

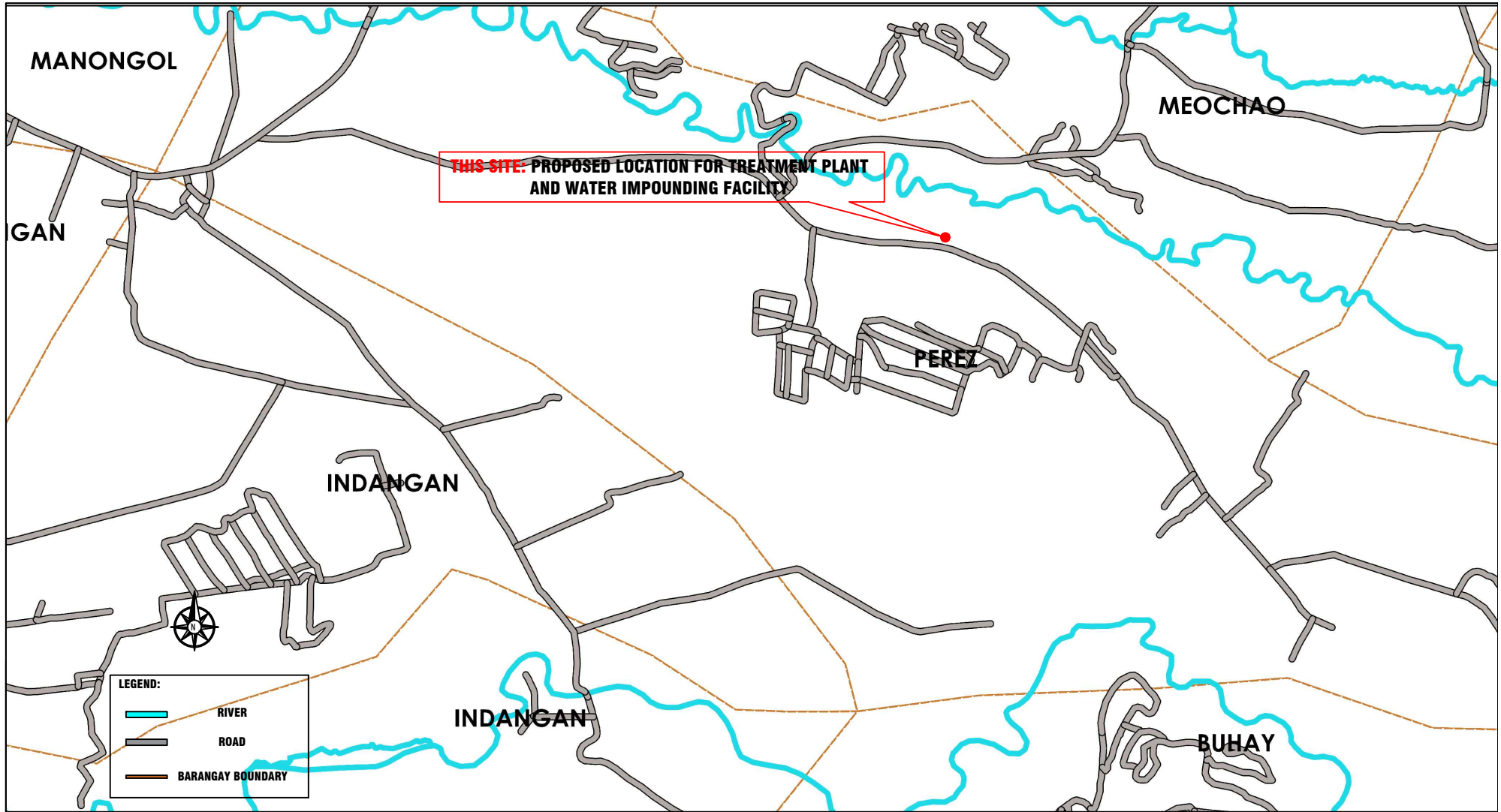



 ISO 9001:2015 CERTIFIED Certificate No. 66478	FROM THE OFFICE OF: METRO KIDAPAWAN WATER DISTRICT ENGINEERING AND OPERATIONS DEPARTMENT PLANNING AND DESIGN DIVISION BRGY. LANAO, KIDAPAWAN CITY	DRAWN BY: GDT DATE: MAY 2020	PROJECT TITLE: INSTALLATION OF WATER IMPOUNDING STRUCTURE AND TREATMENT FACILITY	PREPARED BY: GLYZIEL D. TUMACLAS, CE <small>JOB ORDER - PDD</small> CHECKED BY: CANUTO A. CODILLA, CE <small>DIVISION MANAGER A- PDD</small>	REVIEWED BY: RAMIL A. CONDEZ, CE,RMP,MBA <small>DEPARTMENT MANAGER A ECD</small> RECOMMENDED BY: WILESPER LISANDRO M. ALQUEZA, CE,RMP,MBA <small>ASST. GENERAL MANAGER FOR OPERATION</small>	APPROVED BY: STELLA M. GONZALES, MPS <small>GENERAL MANAGER</small>	SHEET NO: C/01



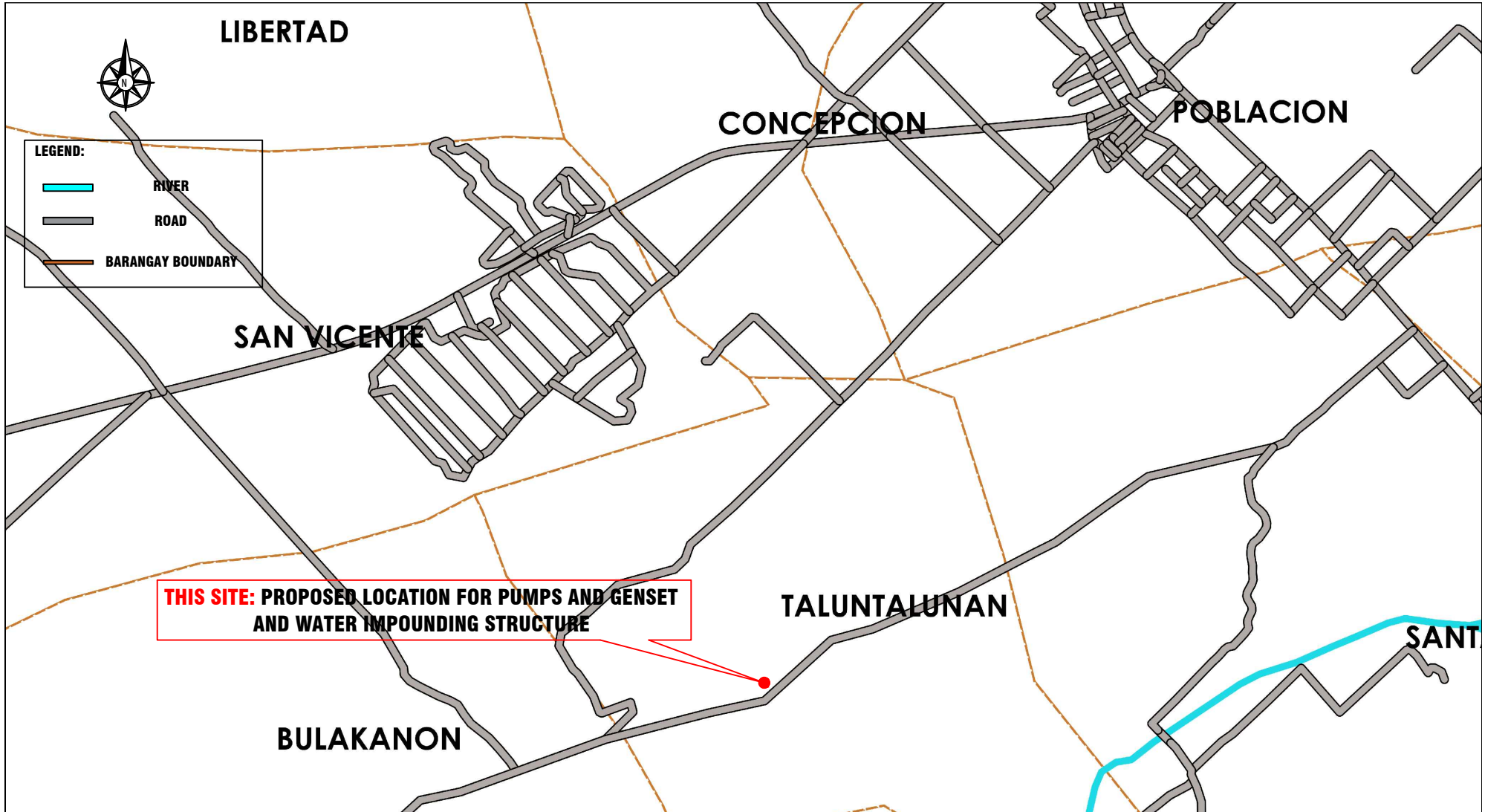

		FROM THE OFFICE OF:	DRAWN BY:	PROJECT TITLE:	PREPARED BY:	REVIEWED BY:	APPROVED BY:	SHEET NO:
		METRO KI DAPAWAN WATER DISTRICT ENGINEERING AND OPERATIONS DEPARTMENT PLANNING and DESIGN DIVISION BRGY. LANAO, KIDAPAWAN CITY	GDT	LAPAAN TREATMENT PLANT FACILITY P3 AND PEREZ WATER IMPOUNDING STRUCTURE 2	GLYZIEL D. TUMACLAS, CE <small>JOB ORDER - PDD</small>	RAMIL A. CONDEZ, CE,RMP,MBA <small>DEPARTMENT MANAGER A ECD</small>	STELLA M. GONZALES, MPS <small>GENERAL MANAGER</small>	C/19
	DATE:		CHECKED BY:	RECOMMENDED BY:				
	MAY 2020		CANUTO A. CODILLA, CE <small>DIVISION MANAGER A- PDD</small>	WILESPER LISANDRO M. ALQUEZA, CE,RMP,MBA <small>ASST. GENERAL MANAGER FOR OPERATION</small>				





LEGEND:

-  RIVER
-  ROAD
-  BARANGAY BOUNDARY

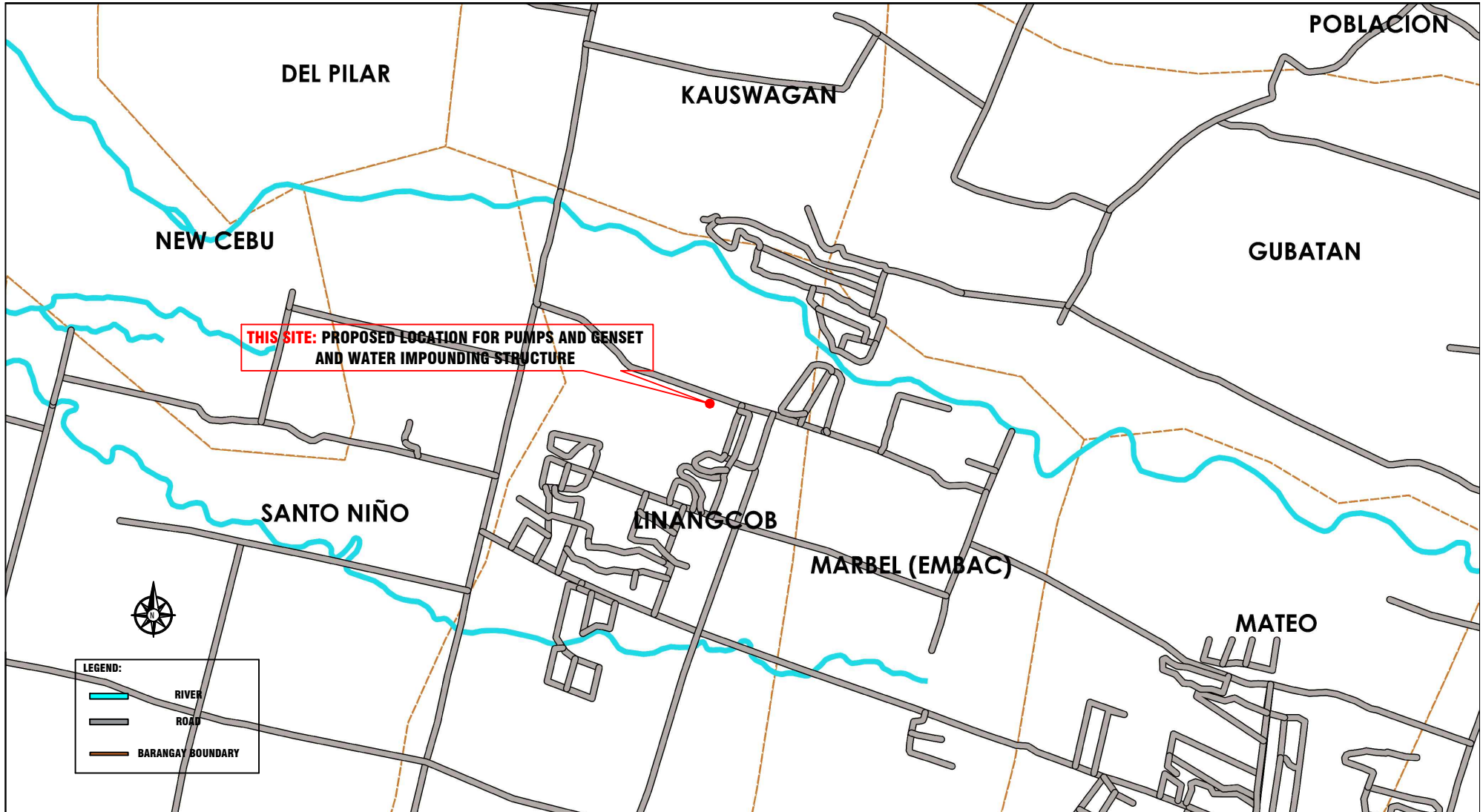

THIS SITE: PROPOSED LOCATION FOR PUMPS AND GENSET AND WATER IMPOUNDING STRUCTURE

	 <p>ISO 9001:2015 CERTIFIED Certificate No. 66478</p>	FROM THE OFFICE OF:	DRAWN BY:	PROJECT TITLE:	PREPARED BY:	REVIEWED BY:	APPROVED BY:	SHEET NO.:
		METRO KI DAPAWAN WATER DISTRICT ENGINEERING AND OPERATIONS DEPARTMENT PLANNING and DESIGN DIVISION BRGY. LANAO, KIDAPAWAN CITY	GDT	TALUNTALUNAN PUMPS AND GENSET AND WATER IMPOUNDING STRUCTURE	<u>GLYZIEL D. TUMACLAS, CE</u> <small>JOB ORDER - PDD</small>	<u>RAMIL A. CONDEZ, CE,RMP,MBA</u> <small>DEPARTMENT MANAGER A ECD</small>	<u>STELLA M. GONZALES, MPS</u> <small>GENERAL MANAGER</small>	C/20
		DATE:	CHECKED BY:	RECOMMENDED BY:				
		MAY 2020	<u>CANUTO A. CODILLA, CE</u> <small>DIVISION MANAGER A- PDD</small>	<u>WILESPER LISANDRO M. ALQUEZA, CE,RMP,MBA</u> <small>ASST. GENERAL MANAGER FOR OPERATION</small>				



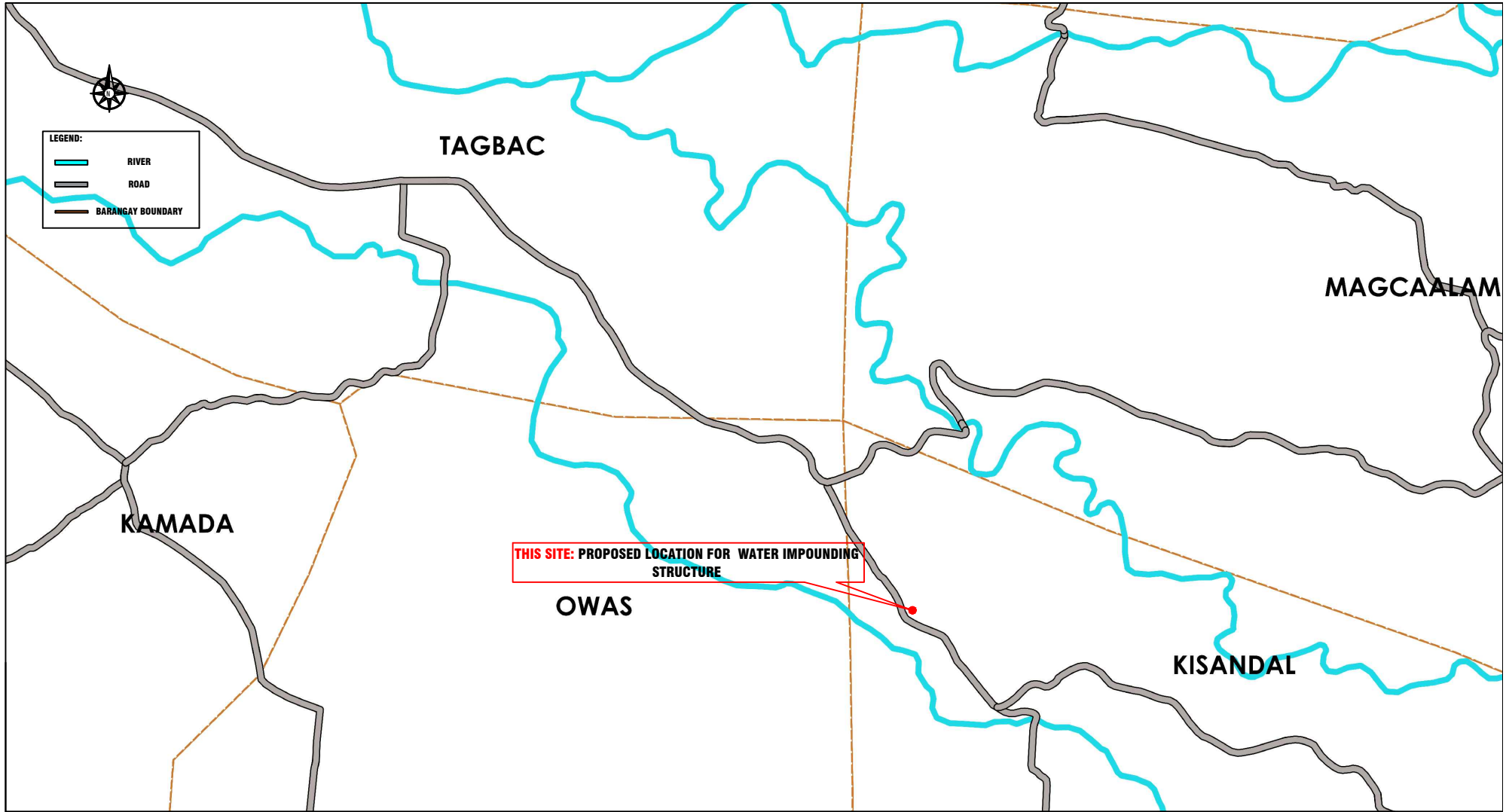

		FROM THE OFFICE OF:	DRAWN BY:	PROJECT TITLE:	PREPARED BY:	REVIEWED BY:	APPROVED BY:	SHEET NO.:
		METRO KI DAPAWAN WATER DISTRICT ENGINEERING AND OPERATIONS DEPARTMENT PLANNING and DESIGN DIVISION BRGY. LANAÓ, KIDAPAWAN CITY	GDT	MARBEL PUMPS AND GENSET AND WATER IMPOUNDING STRUCTURE	<u>GLYZIEL D. TUMACLAS, CE</u> <small>JOB ORDER - PDD</small>	<u>RAMIL A. CONDEZ, CE,RMP,MBA</u> <small>DEPARTMENT MANAGER A ECD</small>	<u>STELLA M. GONZALES, MPS</u> <small>GENERAL MANAGER</small>	C/21
	DATE:		CHECKED BY:	RECOMMENDED BY:				
	MAY 2020		<u>CANUTO A. CODILLA, CE</u> <small>DIVISION MANAGER A- PDD</small>	<u>WILESPER LISANDRO M. ALQUEZA, CE,RMP,MBA</u> <small>ASST. GENERAL MANAGER FOR OPERATION</small>				



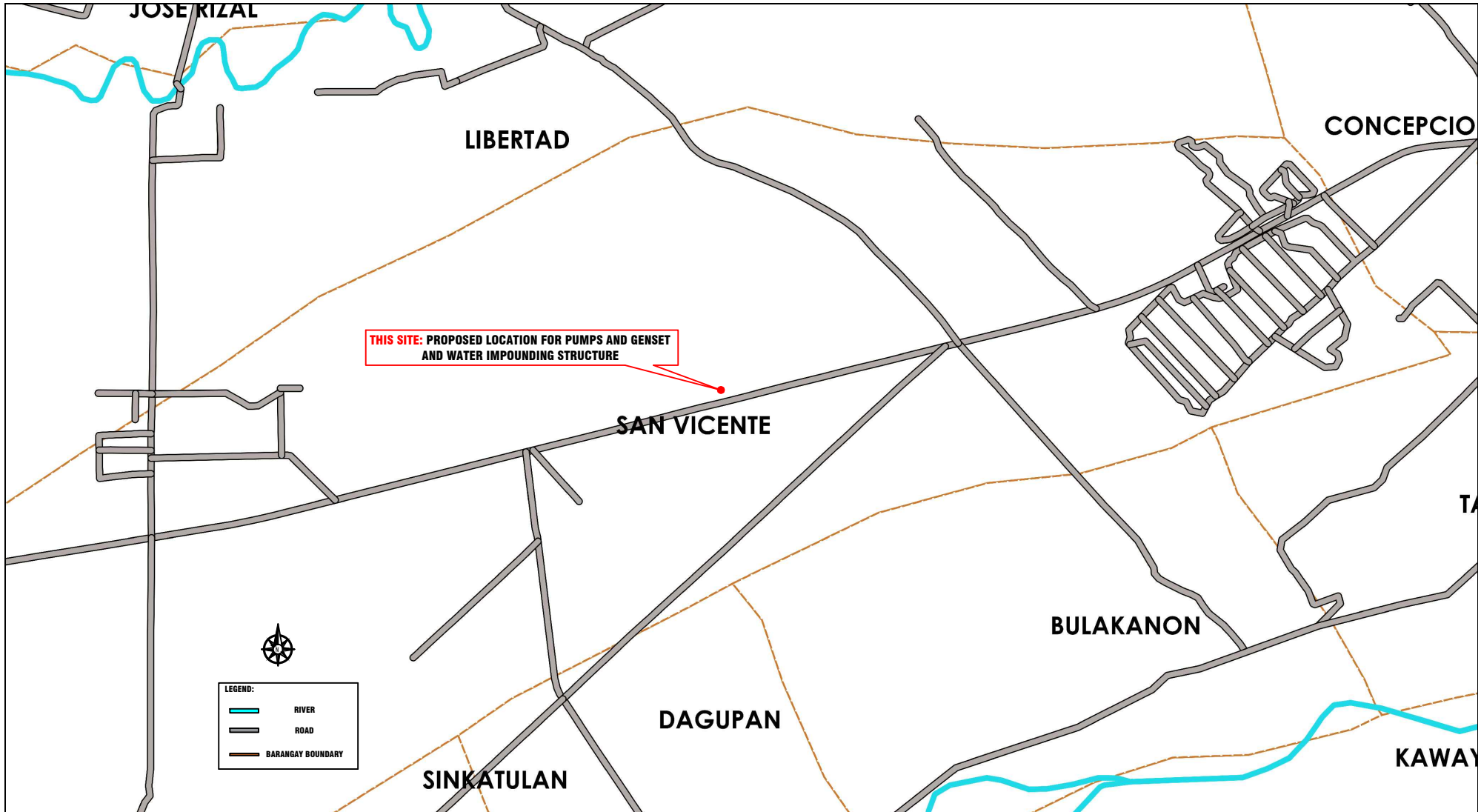

  ISO 9001:2015 CERTIFIED Certificate No. 66478	FROM THE OFFICE OF: METRO KIDAPAWAN WATER DISTRICT ENGINEERING AND OPERATIONS DEPARTMENT PLANNING and DESIGN DIVISION BRGY. LANAO, KIDAPAWAN CITY	DRAWN BY: GDT DATE: MAY 2020	PROJECT TITLE: MAGPET WATER IMPOUNDING STRUCTURE	PREPARED BY: GLYZIEL D. TUMACLAS, CE <small>JOB ORDER - PDD</small> CHECKED BY: CANUTO A. CODILLA, CE <small>DIVISION MANAGER A- PDD</small>	REVIEWED BY: RAMIL A. CONDEZ, CE,RMP,MBA <small>DEPARTMENT MANAGER A ECD</small> RECOMMENDED BY: WILESPER LISANDRO M. ALQUEZA, CE,RMP,MBA <small>ASST. GENERAL MANAGER FOR OPERATION</small>	APPROVED BY: STELLA M. GONZALES, MPS <small>GENERAL MANAGER</small>	SHEET NO: C/22



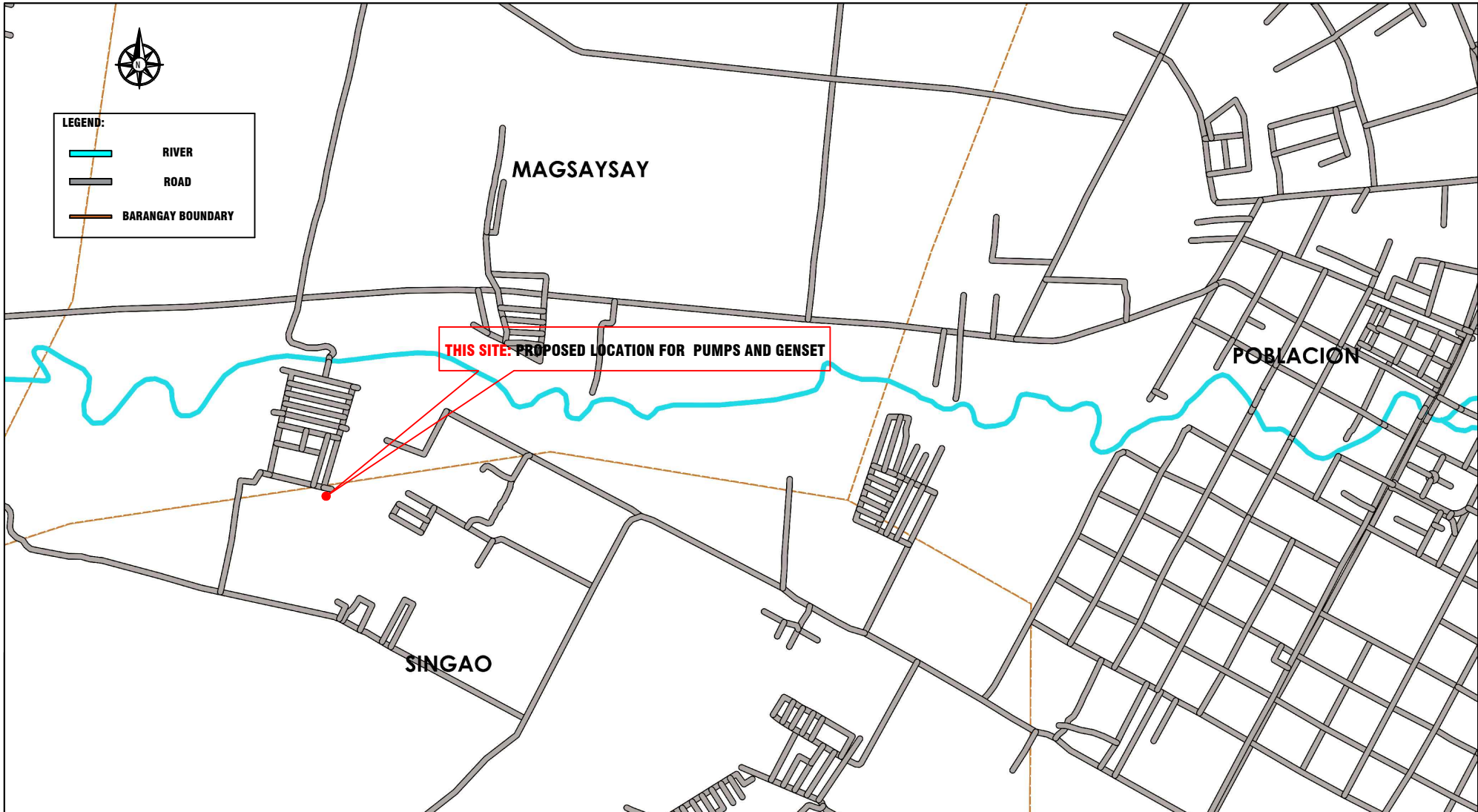

	 ISO 9001:2015 CERTIFIED Certificate No. 66478	FROM THE OFFICE OF:	DRAWN BY:	PROJECT TITLE:	PREPARED BY:	REVIEWED BY:	APPROVED BY:	SHEET NO:
		METRO KI DAPAWAN WATER DISTRICT ENGINEERING AND OPERATIONS DEPARTMENT PLANNING and DESIGN DIVISION BRGY. LANA O, KIDAPAWAN CITY	GDT DATE: MAY 2020	SAN VICENTE PUMPS AND GENSET AND WATER IMPOUNDING STRUCTURE	GLYZIEL D. TUMA CLAS, CE <small>JOB ORDER - PDD</small>	RAMIL A. CONDEZ, CE,RMP,MBA <small>DEPARTMENT MANAGER A ECD</small>	WILESPER LISANDRO M. ALQUEZA, CE,RMP,MBA <small>ASST. GENERAL MANAGER FOR OPERATION</small>	STELLA M. GONZALES, MPS <small>GENERAL MANAGER</small>

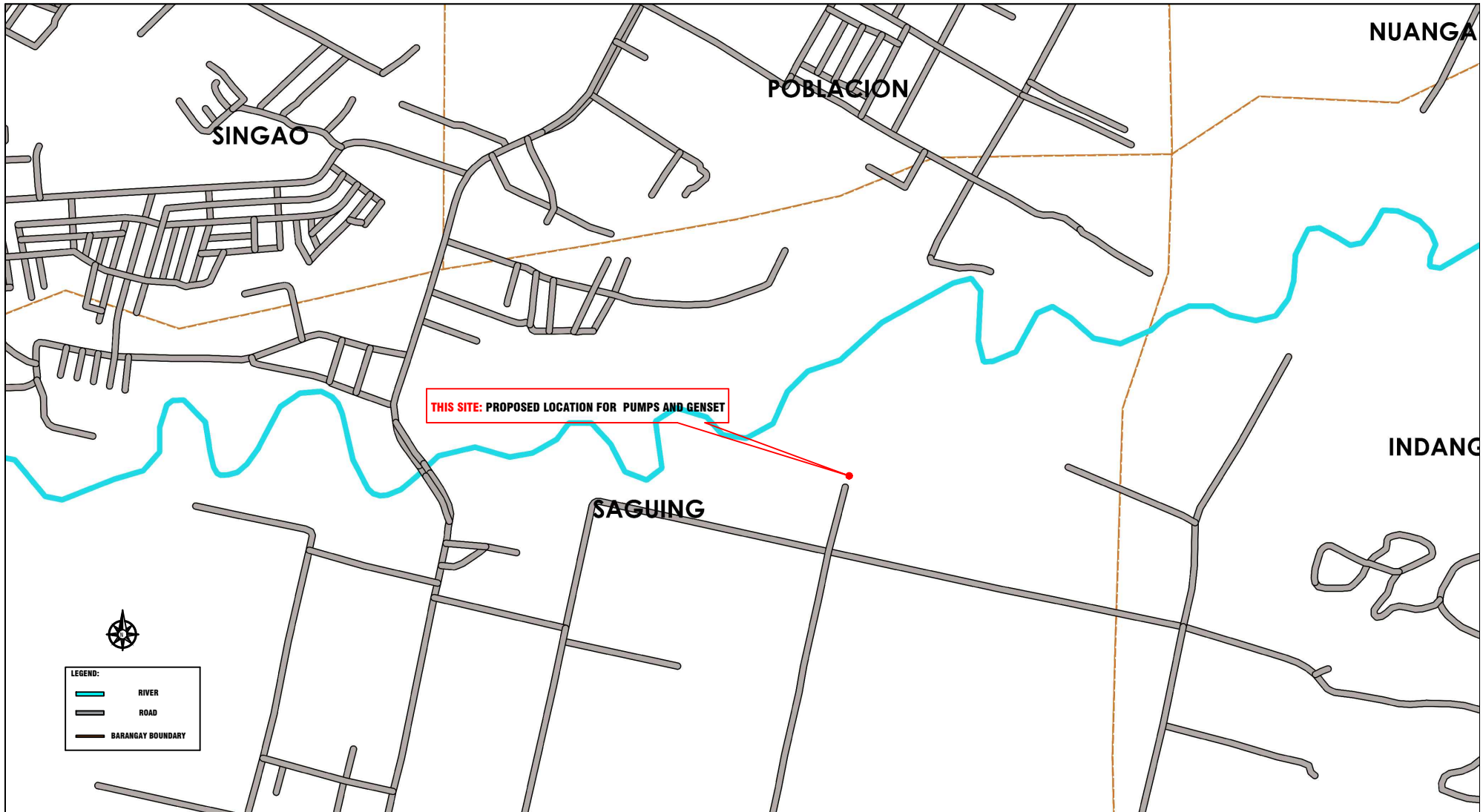

  ISO 9001:2015 CERTIFIED Certificate No. 66478	FROM THE OFFICE OF: METRO KI DAPAWAN WATER DISTRICT ENGINEERING AND OPERATIONS DEPARTMENT PLANNING and DESIGN DIVISION BRGY. LANAOG, KIDAPAWAN CITY	DRAWN BY: GDT	PROJECT TITLE: MAGSASAY PUMPS AND GENSET	PREPARED BY: GLYZIEL D. TUMACLAS, CE <small>JOB ORDER - PDD</small>	REVIEWED BY: RAMIL A. CONDEZ, CE,RMP,MBA <small>DEPARTMENT MANAGER A ECD</small>	APPROVED BY: STELLA M. GONZALES, MPS <small>GENERAL MANAGER</small>	SHEET NO: C/23
		DATE: MAY 2020		CHECKED BY: CANUTO A. CODILLA, CE <small>DIVISION MANAGER A- PDD</small>	RECOMMENDED BY: WILESPER LISANDRO M. ALQUEZA, CE,RMP,MBA <small>ASST. GENERAL MANAGER FOR OPERATION</small>		



		FROM THE OFFICE OF:	DRAWN BY:	PROJECT TITLE:	PREPARED BY:	REVIEWED BY:	APPROVED BY:	SHEET NO.:
		METRO KI DAPAWAN WATER DISTRICT ENGINEERING AND OPERATIONS DEPARTMENT PLANNING and DESIGN DIVISION BRGY. LANAO, KIDAPAWAN CITY	GDT	SAGUING PUMPS AND GENSET	GLYZIEL D. TUMACLAS, CE <small>JOB ORDER - PDD</small>	RAMIL A. CONDEZ, CE,RMP,MBA <small>DEPARTMENT MANAGER A ECD</small>	STELLA M. GONZALES, MPS <small>GENERAL MANAGER</small>	C/25
	DATE: MAY 2020		CANUTO A. CODILLA, CE <small>DIVISION MANAGER A- PDD</small>	WILESPER LISANDRO M. ALQUEZA, CE,RMP,MBA <small>ASST. GENERAL MANAGER FOR OPERATION</small>				

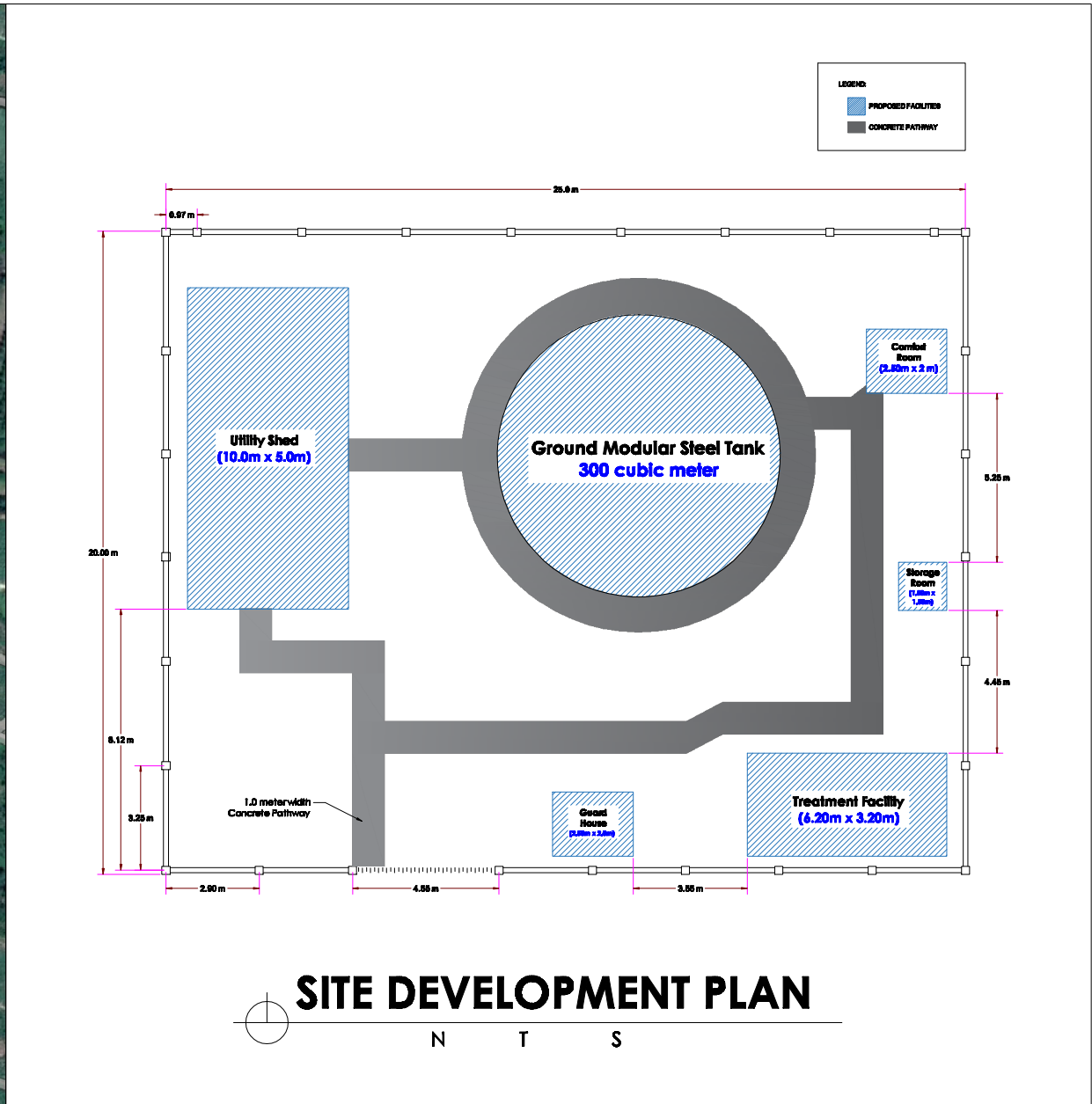

SITE DEVELOPMENT PLAN

	Republic of the Philippines METRO KIDAPAWAN WATER DISTRICT Landa, Kidapawan City Tel no. (064)577-1333, 577-1845, Fax no. (064) 572-5555 E-mail Address: metrokidapawan_wd@yaho.com Website: www.metrokidapawanwd.gov.ph "Committed to Service, Development and Self-Reliance"	Project Title MARBEL WATER IMPOUNDING STRUCTURE	Location Barangay Marbel, Magpet, Kidapawan City	Prepared By MARY JOELLE C. TABAGA, CE CADRAL - PDD	Reviewed By RAMIL A. CONDEZ, CE, RMP, MBA DEPARTMENT MANAGER A EDD	Approved By STELLA M. GONZALES, MPS GENERAL MANAGER	A / 29
	Sheet Content VICINITY MAP / SITE DEVELOPMENT PLAN	Drawn By MUCTAIRA	Date OCTOBER 2019	Checked By CANUTO A. CODILLA JR., CE DIVISION MANAGER A EDD	Recommending Approval WILESPER LISANDRO M. ALQUEZA, CE, RMP, MBA ASST. GENERAL MANAGER FOR OPERATION		

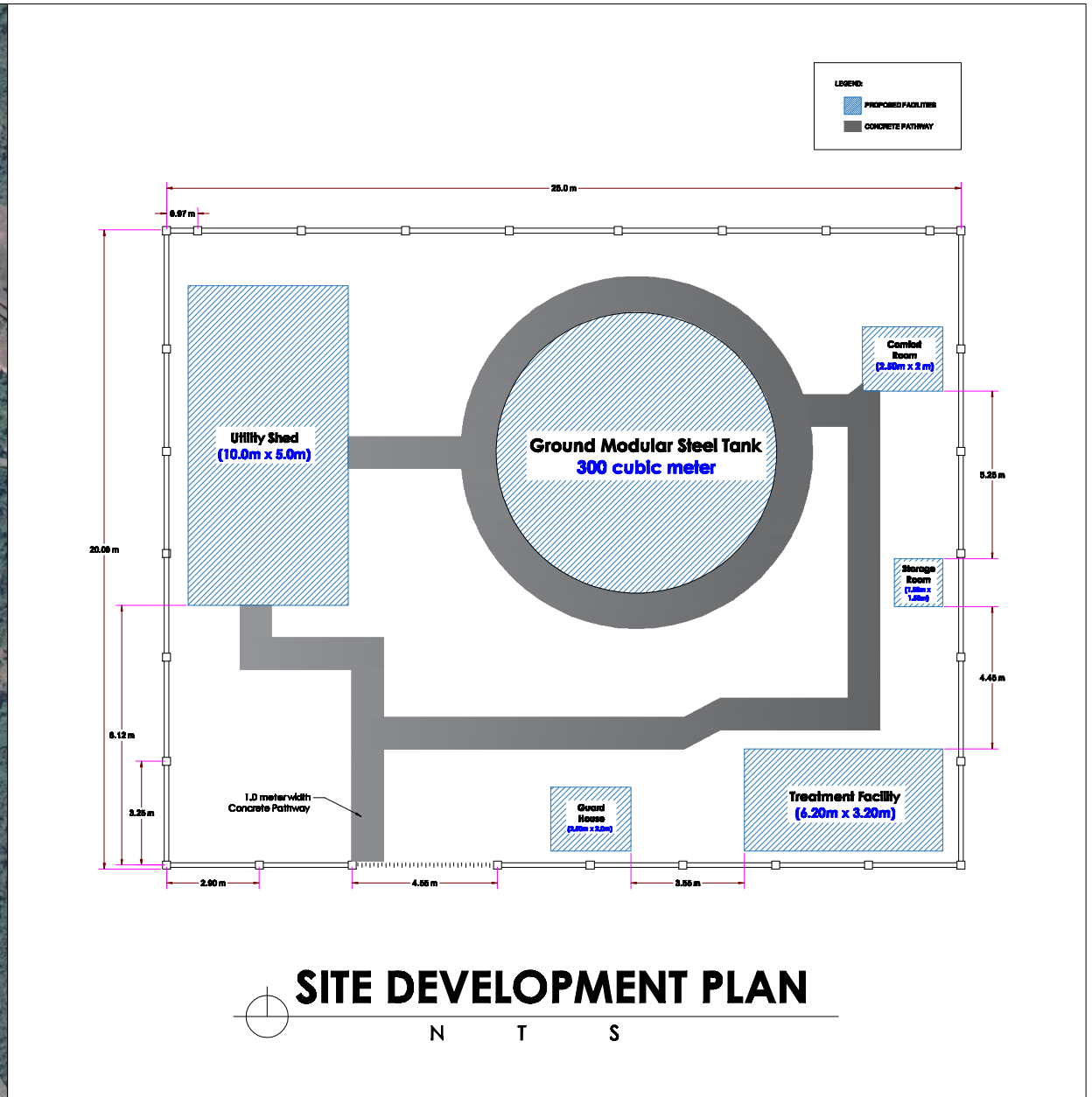

SITE DEVELOPMENT PLAN

			PROJECT OFFICE ON Republic of the Philippines METRO KIDAPAWAN WATER DISTRICT Lanao, Kidapawan City Tel. nos. (064)577-1533, 577-1865, Fax no. (064) 572-5555 E-mail Address: metrokidapawan_wd@nwas.com Website: www.metrokidapawan.gov.ph "Committed to Service, Development and Self-Reliance"	Project Title MAGPET WATER IMPOUNDING STRUCTURE	Location Barangay Tagbac, Municipality of Magpet	Prepared By MARY JOELLE C. TABAGA, CE CONSULTANT - PSD	Reviewed By RAMIL A. CONDEZ, CE, RMP, MBA DEPARTMENT MANAGER A EDO	Approved By STELLA M. GONZALES, NPS GENERAL MANAGER	Sheet no. A / 45
			Sheet Content VICINITY MAP / SITE DEVELOPMENT PLAN	Drawn By MCTABAGA	Date OCTOBER 2019	Checked By CANUTO A. CODILLA JR., CE DIVISION MANAGER A EDO	Processing/Approvals WILESPER LISANDRO M. ALQUEZA, CE, RMP, MBA ASST. GENERAL MANAGER FOR OPERATION		

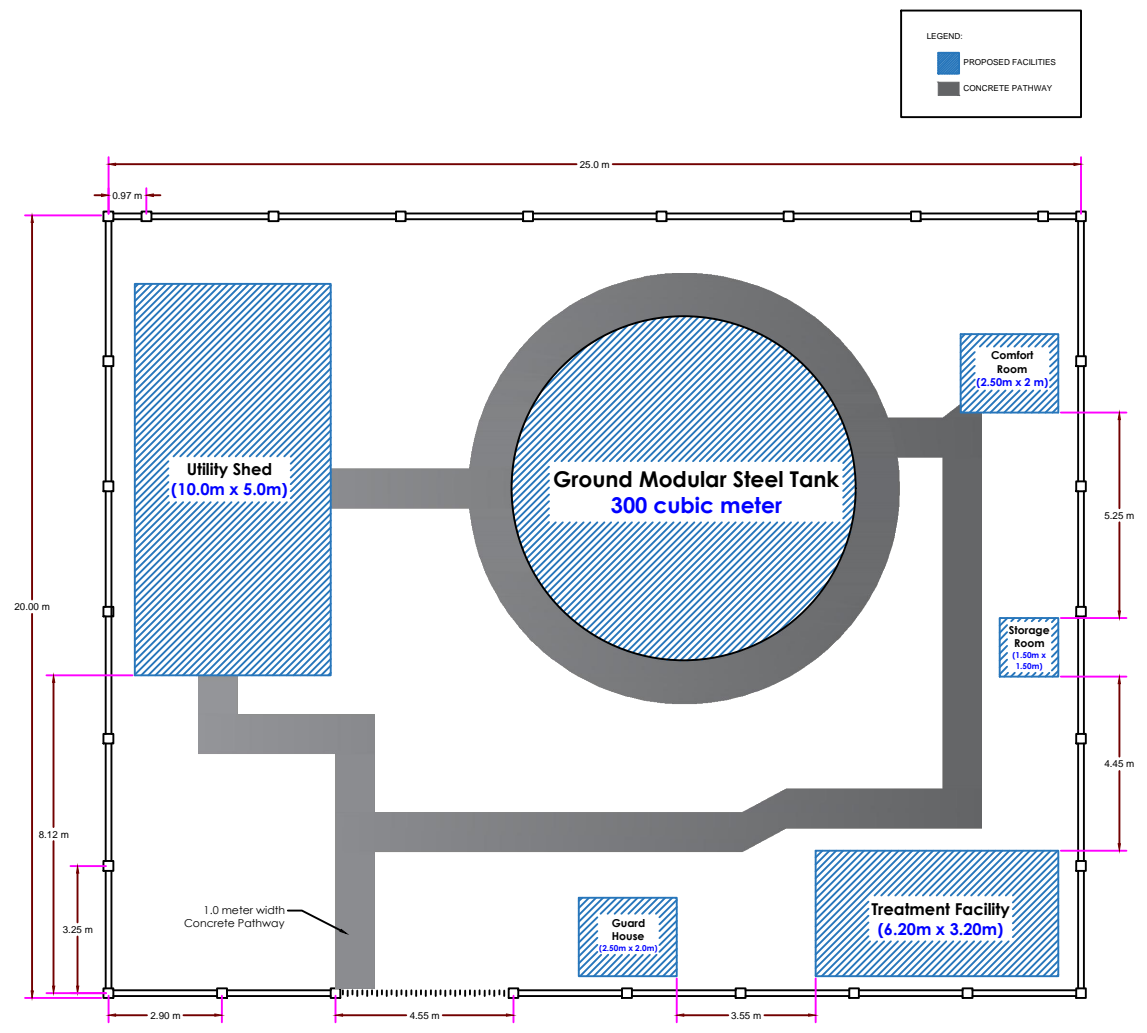

SITE DEVELOPMENT PLAN

N T S

<p>ISO 9001 QUALITY MANAGEMENT</p> <p>UKAS WATER QUALITY SYSTEMS 415</p> <p>ISO 9001:2015 CERTIFIED Certificate No. 64478</p>	<p>FROM THE OFFICE OF:</p> <p>Republic of the Philippines METRO KIDAPAWAN WATER DISTRICT Lanao, Kidapawan City Tel nos. (064)577-1533, 577-1865, Fax no. (064) 572-5555 E-mail Address: metrokidapawan_wd@yahoo.com Website: www.metrokidapawanwd.gov.ph "Committed to Service, Development and Self-Reliance"</p>	<p>Project Title:</p> <p>KALAIKAN WATER IMPOUNDING STRUCTURE</p>	<p>Location:</p> <p>Barangay Kalaisan, Kidapawan City</p>	<p>Prepared By:</p> <p>MARY JOSELLE C. TABASA, CE CASUAL - PDD</p>	<p>Reviewed By:</p> <p>RAMIL A. CONDEZ, CE, RMP, MBA DEPARTMENT MANAGER A ECD</p>	<p>Approved By:</p> <p>STELLA M. GONZALES, MPS GENERAL MANAGER</p>	<p>Sheet no.</p> <p>A / 62</p>
	<p>Sheet Content:</p> <p>VICINITY MAP / SITE DEVELOPMENT PLAN</p>	<p>Drawn By:</p> <p>MJCTABASA</p>	<p>Date:</p> <p>OCTOBER 2019</p>	<p>Checked By:</p> <p>CANUTO A. CODILLA JR., CE DIVISION MANAGER A ECD</p>	<p>Recommending Approval:</p> <p>WILESPER LISANDRO M. ALQUEZA, CE, RMP, MBA ASST. GENERAL MANAGER FOR OPERATION</p>		

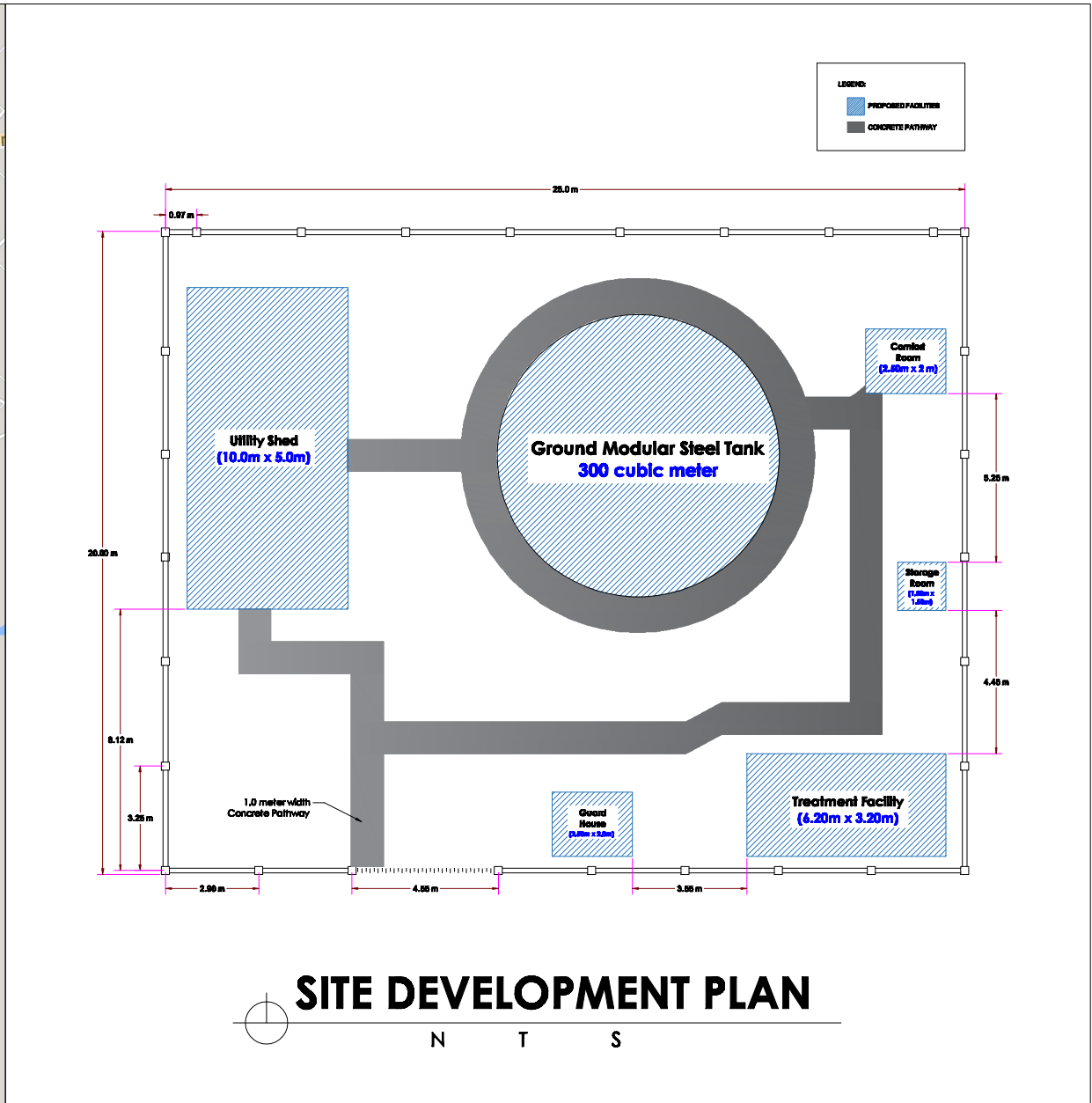

	FROM THE OFFICE OF: Republic of the Philippines METRO KIDAPAWAN WATER DISTRICT Loroño, Kidapawan City Tel no. (084) 577-1833, 577-1845, Fax no. (084) 572-5555 E-mail Address: metrokidapawan_wd@yafco.com Website: www.metrokidapawanwd.gov.ph "Committed to Service, Development and Self-Reliance"	Project Title: TALUNTALUNAN WATER IMPOUNDING STRUCTURE	Location: Barangay Taluntalunan, Municipality of Kidapawan	Prepared By: MARY JOELLE C. TABASA, CE CADRAL - PEO	Reviewed By: RAMIL A. CONDEZ, CE, RMP, MBA DEPARTMENT MANAGER A EDD	Approved By: STELLA M. GONZALES, MPS GENERAL MANAGER	A / 70
	Sheet Content: VICINITY MAP / SITE DEVELOPMENT PLAN	Drawn By: MDCTANASA	Date: OCTOBER 2019	Checked By: CANUTO A. COBILLA JR., CE DIVISION MANAGER A EDD	Recommending Approver: WILESPER LISANDRO M. ALQUEZA, CE, RMP, MBA ASST. GENERAL MANAGER FOR OPERATION		

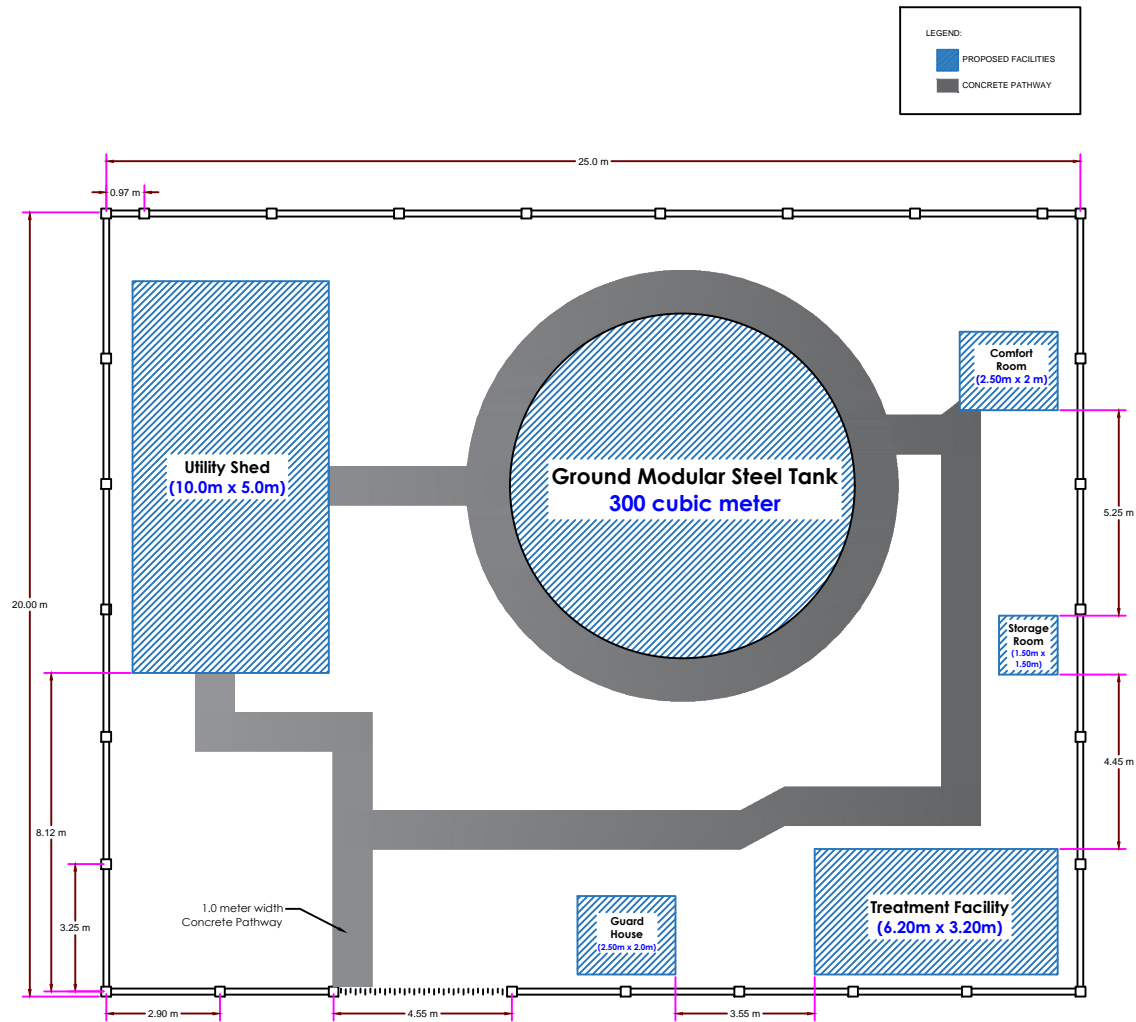
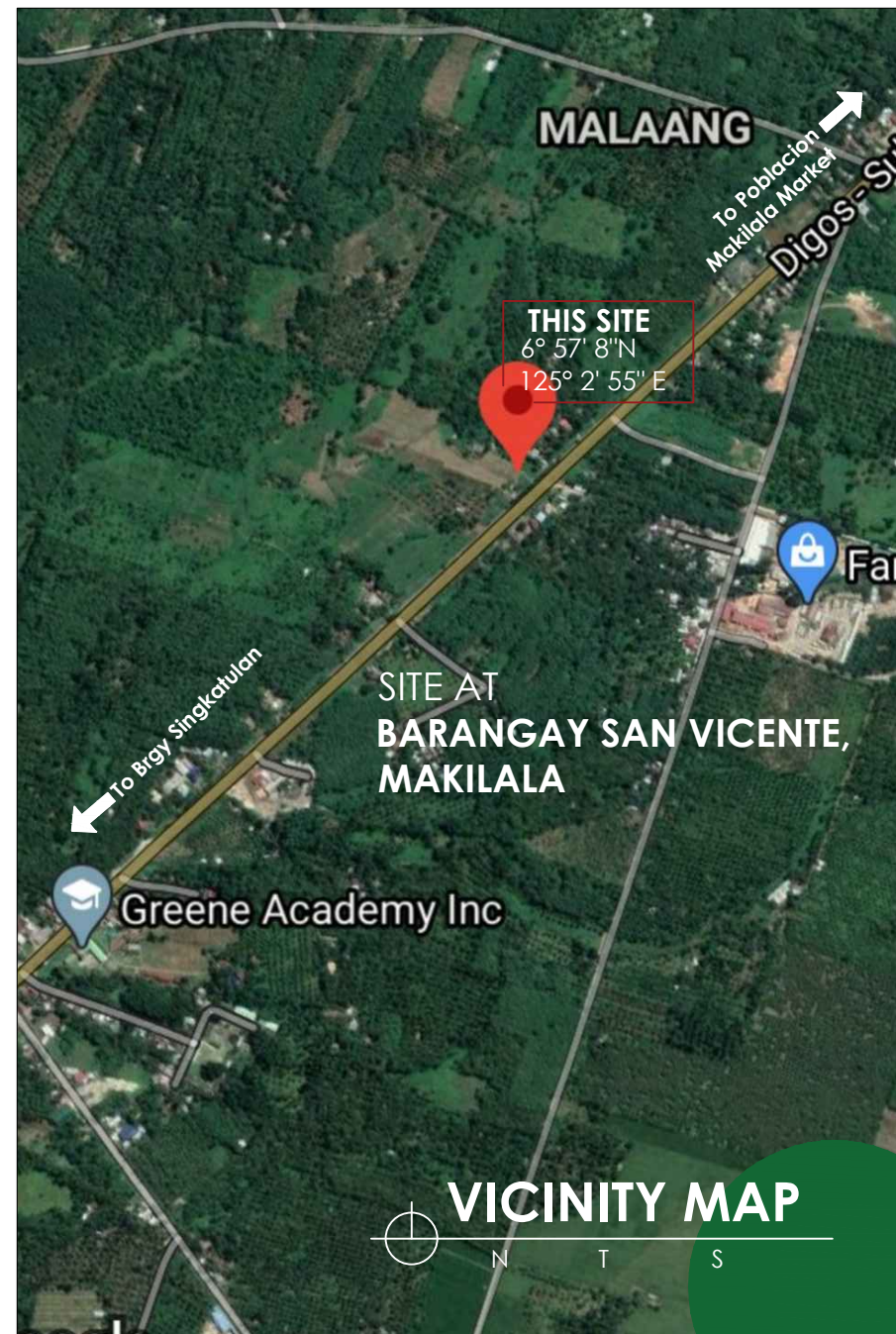



SITE DEVELOPMENT PLAN

VICINITY MAP

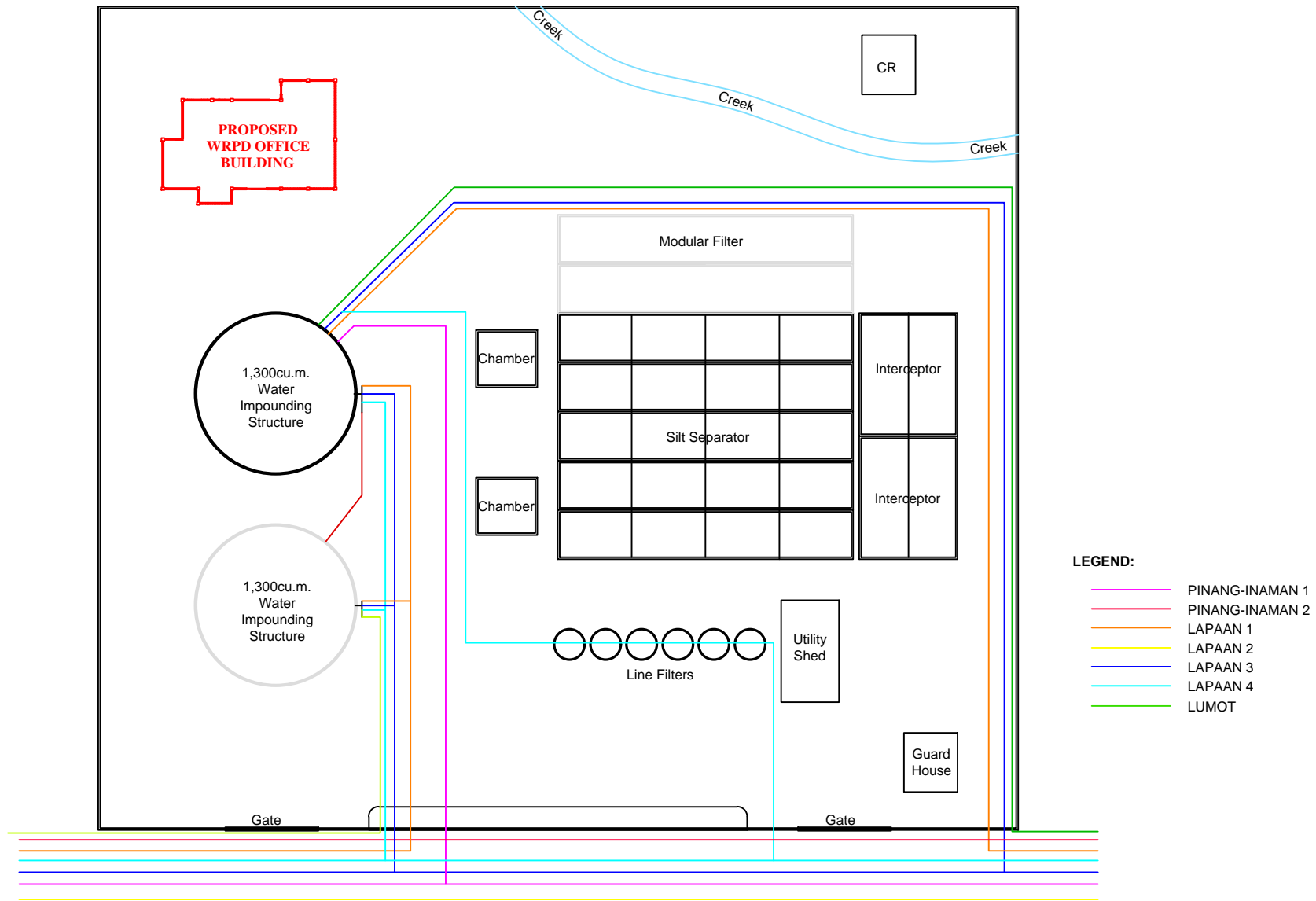
	FROM THE OFFICE OF: Republic of the Philippines METRO KIDAPAWAN WATER DISTRICT Lanao, Kidapawan City Tel nos. (064)577-1533, 577-1865, Fax no. (064) 572-5555 E-mail Address: metrokidapawan_wd@yahoo.com Website: www.metrokidapawanwd.gov.ph <i>"Committed to Service, Development and Self-Reliance"</i>	Project Title: SAN VICENTE WATER IMPOUNDING STRUCTURE	Location: Barangay San Vicente, Makilala	Prepared By: MARY JOSELLE C. TABASA, CE <small>CASUAL - PDD</small>	Reviewed By: RAMIL A. CONDEZ, CE, RMP, MBA <small>DEPARTMENT MANAGER A ECD</small>	Approved By: STELLA M. GONZALES, MPS <small>GENERAL MANAGER</small>	Sheet no. A / 79
	SHEET CONTENT: VICINITY MAP / SITE DEVELOPMENT PLAN	Drawn By: MICTABASA	Date: OCTOBER 2019	Checked By: CANUTO A. CODILLA JR., CE <small>DIVISION MANAGER A ECD</small>	Recommending Approval: WILESPER LISANDRO M. ALQUEZA, CE, RMP, MBA <small>ASST. GENERAL MANAGER FOR OPERATION</small>		



SCHEMATIC DIAGRAM

		From the Office of:	Project Title:	Location:	Prepared by:	Reviewed by:	Approved by:	Sheet No.
		Republic of the Philippines METRO KIDAPAWAN WATER DISTRICT Brgy. Lantao, Kidapawan City Tel Nos: (064)577-1533; 577-1865 E-mail Address: metrokidapawan_wd@yahoo.com Website: www.metrokidapawanwd.gov.ph <i>"Committed to Service, Development and Self-Reliance"</i>	LAPAAN TREATMENT PLANT FACILITY AND WATER IMPOUNDING STRUCTURE	Brgy. Perez, Kidapawan City	ENGR. ROLAN SEAN U. MAGAWAY Senior Engineer A - PDD	ENGR. RAMIL A. CONDEZ, RMP/MBA Department Manager A - ECD	STELLA M. GONZALES, MPS General Manager	A/27
SCHEMATIC DIAGRAM	Drawn By: RSUM	Date: OCT 2019	Checked by: ENGR. CANUTO A. CODILLA, JR. Division Manager A - PDD	Recommending Approval: ENGR. WILESPER LISANDRO M. ALQUEZA, RMP/MBA AGM for Operations				

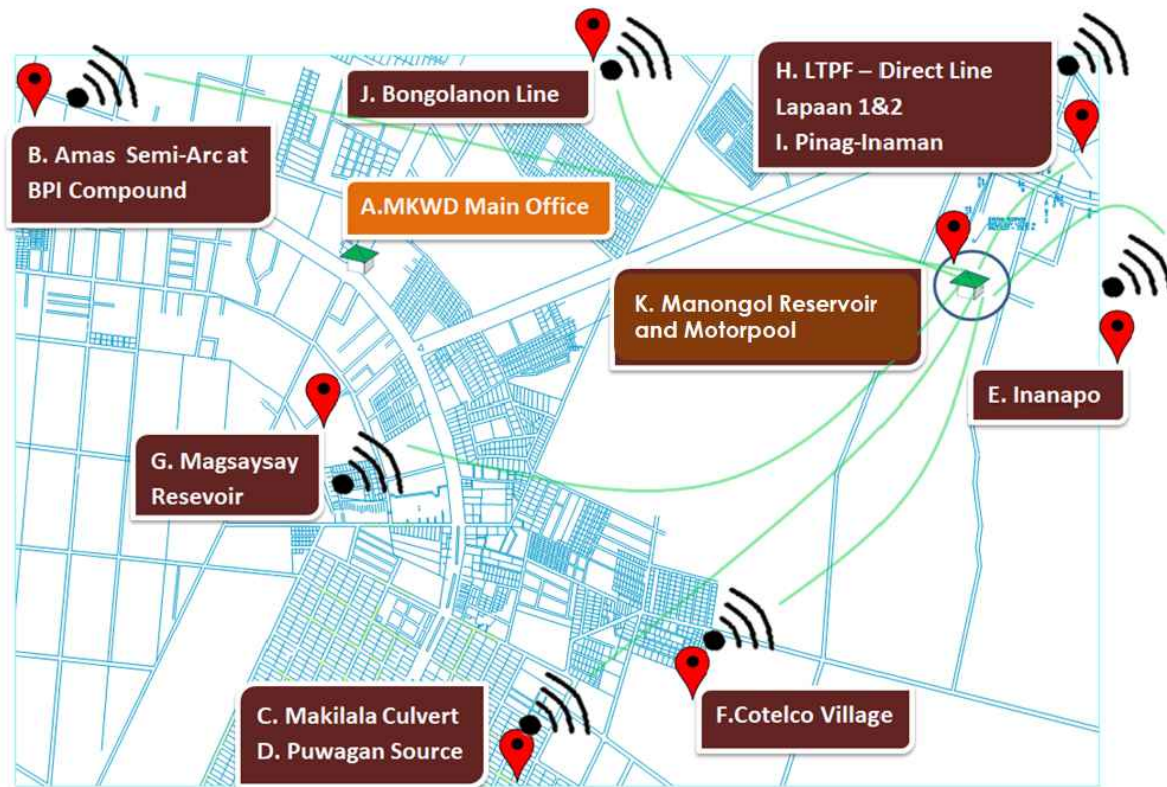

DATA LOGGERS FOR EXISTING FLOW METERS

LEGEND:

STATION		Distance of Facilities		
FROM	TO	ROUTE DISTANCE (km)	PLANE AERIAL DISTANCE (km)	No. of Units
K	A	3.50	2.90	
K	B	15.0	14.30	1
K	C	11.0	8.0	2
K	D	12.0	10.50	1
K	E	16.0	12.0	1
K	F	6.50	5.50	1
K	G	6.50	5.0	1
K	H	6.0	4.50	9
K	I	7.50	6.0	1
K	J	10.0	8.50	2

A=MKWD MAIN BUILDING
 B=AMAS AREA/SEMI ARC
 C=MAKILALA AREA
 D=PUWAGAN SOURCE
 E=INANAPO SOURCE
 F=COTELCO VILLAGE RESERVOIR

G=MAGSAYSAY RESERVOIR
 H=LAPAAN TREATMENT PLANT FACILITY
 I=PINAG-INAMAN SOURCE
 J=BONGOLANON SOURCE
 K=MANONGOL RESERVOIR/MAIN STATION

		FROM THE OFFICE OF:	DRAWN BY:	PROJECT TITLE:	PREPARED BY:	REVIEWED BY:	APPROVED BY:	SHEET NO.:
		METRO KI DAPAWAN WATER DISTRICT ENGINEERING AND OPERATIONS DEPARTMENT PLANNING and DESIGN DIVISION BRGY. LANAO, KIDAPAWAN CITY	ABNL DATE: MAY 2020	DATA LOGGERS FOR EXISTING FLOW METERS	ACE BRYAN-NIÑO T. LLESOL <small>Sr. DRAFTSMAN A - PDD</small>	RAMIL A. CONDEZ, CE,RMP,MBA <small>DEPARTMENT MANAGER A ECD</small>	STELLA M. GONZALES, MPS <small>GENERAL MANAGER</small>	C/15
					CANUTO A. CODILLA, CE <small>DIVISION MANAGER A - PDD</small>	WILESPER LISANDRO M. ALQUEZA, CE,RMP,MBA <small>ASST. GENERAL MANAGER FOR OPERATION</small>		

INSTALLATION OF DATA LOGGERS FOR RESERVOIRS

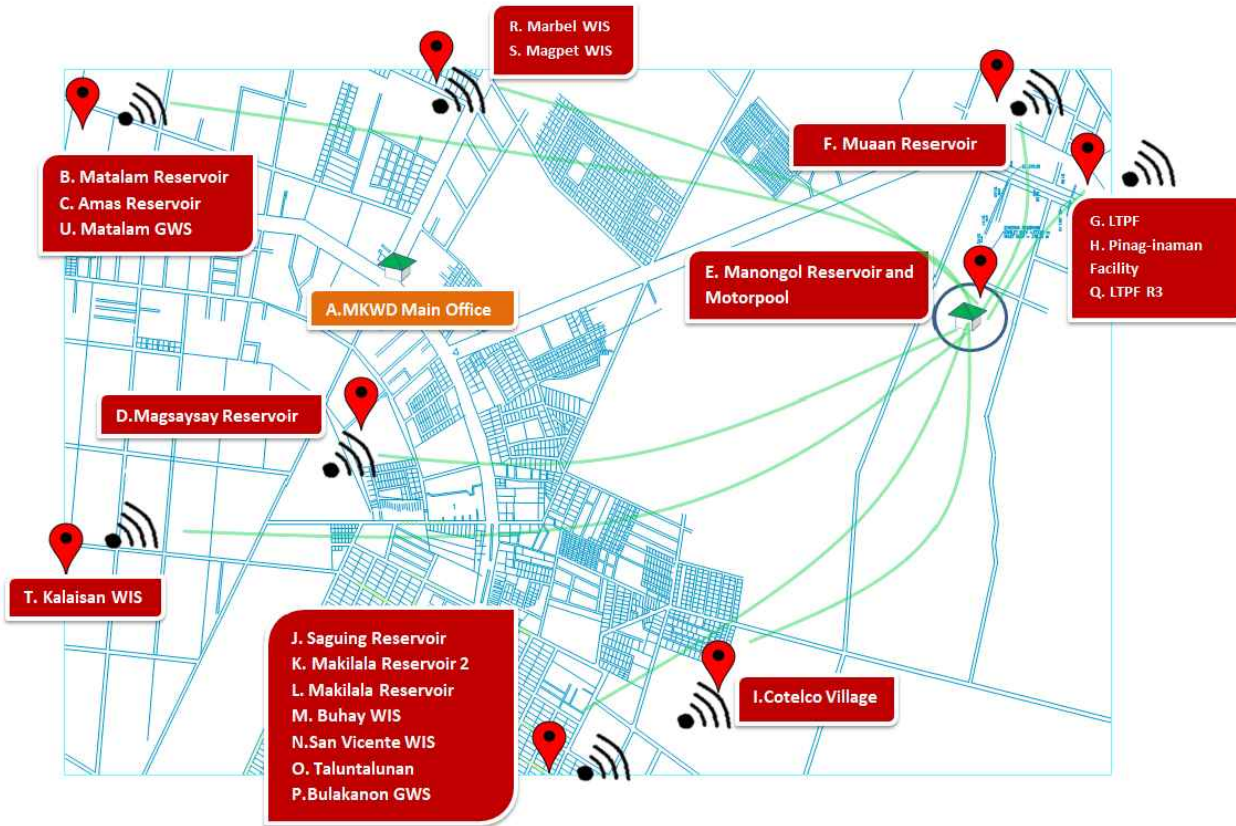

Distance of Facilities			
STATION FROM	TO	ROUTE DISTANCE (km)	PLANE AERIAL DISTANCE (km)
E	A	3.50	2.90
E	B	26.5	24.80
E	C	15.0	14.30
E	D	6.50	5.0
E	E	On same site	On same site
E	F	8.50	7.00
E	G	6.0	4.50
E	I	6.50	5.50
E	J	10.0	7.0
E	K	11.0	8.0
E	L	14.0	12.0
E	M	36.0	25.0
E	N	15.0	13.50
E	O	20.0	17.0
E	P	23.0	18.0
E	Q	6.0	4.50
E	R	10.0	9.0
E	S	10.0	7.0
E	T	7.50	6.0
E	U	28.0	26.0

- LEGEND:**
 A=MKWD MAIN BUILDING
 B=MATALAM RESERVOIR
 C=AMAS RESERVOIR
 D=MAGSAYSAY RESERVOIR
 E=MANONGOL RESERVOIR
 F=MUAAN RESERVOIR
 G=LTPF RESERVOIR 2
 I=COTELCO VILLAGE RESERVOIR
 J=SAGUING RESERVOIR
 K=MAKILALA RESERVOIR 2
 L=MAKILALA RESERVOIR
 M=BUHAY WATER IMPOUNDING STRUCTURE
 N=SAN VICENTE WATER IMPOUNDING STRUCTURE
 O=TALUNTALUNAN WATER IMPOUNDING STRUCTURE
 P=BULAKANON GROUND WATER SOURCE
 Q=LTPF RESERVOIR 3
 R=MARBEL WATER IMPOUNDING STRUCTURE
 S=MAGPET WATER IMPOUNDING STRUCTURE
 T=KALAISAN GROUND WATER SOURCE
 U=MATALAM GROUND WATER SOURCE

<p>ISO 9001 QUALITY MANAGEMENT</p> <p>ISO 9001:2015 CERTIFIED Certificate No. 66478</p>	<p>FROM THE OFFICE OF:</p> <p>METRO KI DAPAWAN WATER DISTRICT ENGINEERING AND OPERATIONS DEPARTMENT PLANNING and DESIGN DIVISION</p> <p>BRGY. LANAOG, KIDAPAWAN CITY</p>	<p>DRAWN BY:</p> <p>ABNL</p> <p>DATE:</p> <p>MAY 2020</p>	<p>PROJECT TITLE:</p> <p>INSTALLATION OF DATA LOGGERS FOR RESERVOIRS</p>	<p>PREPARED BY:</p> <p>ACE BRYAN-NIÑO T. LLESOL <small>SR. DRAFTSMAN A - PDD</small></p> <p>CHECKED BY:</p> <p>CANUTO A. CODILLA, CE <small>DIVISION MANAGER A- PDD</small></p>	<p>REVIEWED BY:</p> <p>RAMIL A. CONDEZ, CE,RMP,MBA <small>DEPARTMENT MANAGER A ECD</small></p> <p>RECOMMENDED BY:</p> <p>WILESPER LISANDRO M. ALQUEZA, CE,RMP,MBA <small>ASST. GENERAL MANAGER FOR OPERATION</small></p>	<p>APPROVED BY:</p> <p>STELLA M. GONZALES, MPS <small>GENERAL MANAGER</small></p>	<p>SHEET NO:</p> <p>C/16</p>
---	---	---	---	---	--	---	-------------------------------------

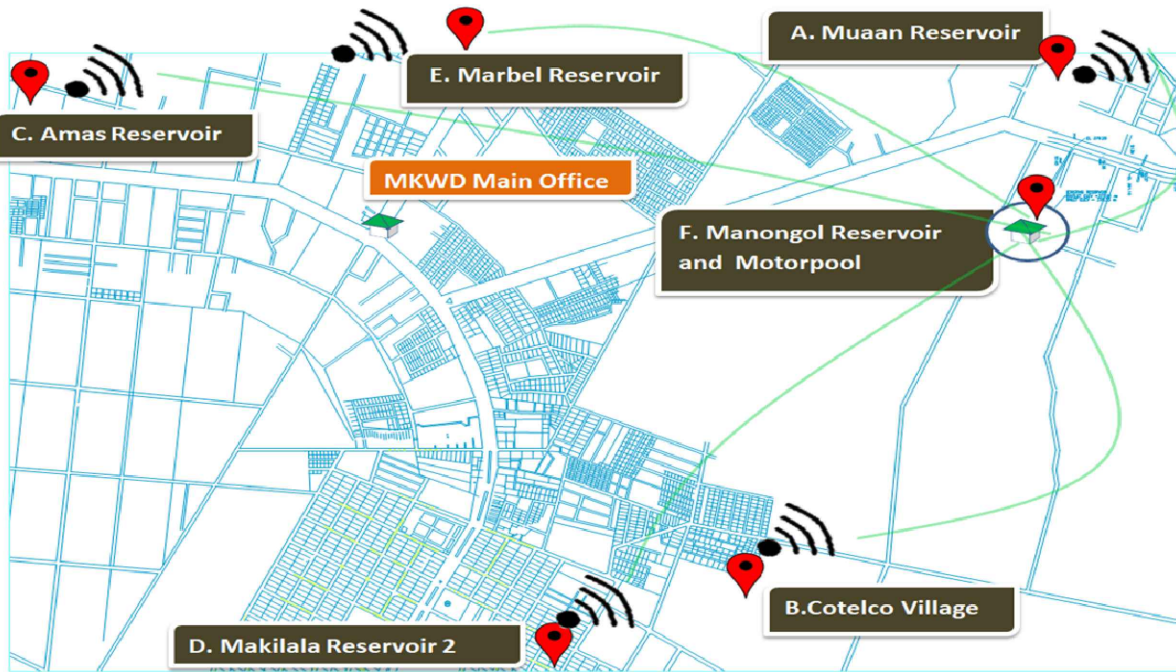



PUMPING FACILITY MONITORING EQUIPMENTS

STATION		Distance of Facilities		
FROM	TO	ROUTE DISTANCE (km)	PLANE AERIAL DISTANCE (km)	No. of Units
F	A	7.5	6.5	1
F	B	7.0	6.0	1
F	C	15.0	13.50	1
F	D	12.0	10.0	1
F	E	9.0	8.0	1

LEGEND:

- A = Muan Reservoir
- B = Cotelco Village Reservoir
- C = Amas Reservoir
- D = Makilala Reservoir 2
- E = Marbel Reservoir
- F = Manongol Reservoir

		FROM THE OFFICE OF:	DRAWN BY:	PROJECT TITLE:	PREPARED BY:	REVIEWED BY:	APPROVED BY:	SHEET NO:
		METRO KI DAPAWAN WATER DISTRICT ENGINEERING AND OPERATIONS DEPARTMENT PLANNING and DESIGN DIVISION BRGY. LANAO, KIDAPAWAN CITY	ABNL DATE: MAY 2020	PUMPING FACILITY MONITORING EQUIPMENT	ACE BRYAN-NIÑO T. LLESOL <small>Sr. CIVIL ENGINEER - PDD</small>	RAMIL A. CONDEZ, CE,RMP,MBA <small>DEPARTMENT MANAGER A ECD</small>	STELLA M. GONZALES, MPS <small>GENERAL MANAGER</small>	
					CANUTO A. CODILLA, CE <small>DIVISION MANAGER A- PDD</small>	WILESPER LISANDRO M. ALQUEZA, CE,RMP,MBA <small>ASST. GENERAL MANAGER FOR OPERATION</small>		C/17



INSTALLATION OF CCTV SYSTEM

STATION		Distance of Facilities		
FROM	TO	ROUTE DISTANCE (km)	PLANE AERIAL DISTANCE (km)	No. of Units
E	B	23.00	21.60	3
E	C	11.60	11.40	2
E	D	2.60	2.10	2
E	E	3.50	2.90	2
E	F	8.50	7.00	2
E	G	9.00	7.80	5
E	H	11.00	10.00	2
E	I	3.50	2.50	2
E	J	7.00	4.00	2
E	K	8.00	5.20	2
E	L	11.00	9.00	2

LEGEND:

- A = MKWD main office
- B = Matalam Reservoir
- C = Amas Reservoir
- D = Magsaysay Reservoir
- E = Manongol Reservoir and Motorpool
- F = Muaan Reservoir
- G = Lapaan Treatment Plant Facilities
- H = Pinag-inaman Facility

- I = Coteleo Village Reservoir
- J = Saguiling Reservoir
- K = Makilala Reservoir 2
- L = Makilala Reservoir

<p>ISO 9001:2015 CERTIFIED Certificate No. 66478</p>	<p>FROM THE OFFICE OF:</p> <p>METRO KI DAPAWAN WATER DISTRICT ENGINEERING AND OPERATIONS DEPARTMENT PLANNING and DESIGN DIVISION</p> <p>BRGY. LANAOG, KIDAPAWAN CITY</p>	<p>DRAWN BY:</p> <p>ABNL</p> <p>DATE:</p> <p>MAY 2020</p>	<p>PROJECT TITLE:</p> <p>INSTALLATION OF CCTV SYSTEM</p>	<p>PREPARED BY:</p> <p>ACE BRYAN-NIÑO T. LLESOL <small>SI, DRAFTSMAN A - PDD</small></p> <p>CHECKED BY:</p> <p>CANUTO A. CODILLA, CE <small>DIVISION MANAGER A- PDD</small></p>	<p>REVIEWED BY:</p> <p>RAMIL A. CONDEZ, CE,RMP,MBA <small>DEPARTMENT MANAGER A ECD</small></p> <p>RECOMMENDED BY:</p> <p>WILESPER LISANDRO M. ALQUEZA, CE,RMP,MBA <small>ASST. GENERAL MANAGER FOR OPERATION</small></p>	<p>APPROVED BY:</p> <p>STELLA M. GONZALES, MPS <small>GENERAL MANAGER</small></p>	<p>SHEET NO:</p> <p>C/18</p>
--	---	---	---	---	--	--	-------------------------------------

NEWLY CONSTRUCTED PROVINCIAL FOREST RESERVED AREA PERIMETER FENCE



AMAS RESERVOIR COMPOUND

EXISTING 1.20M X 28.00M
CYCLONE FENCE

**PROPOSED
CCTV 1**

**PROPOSED
CCTV
MONITOR**

GUARD
HOUSE



**PROPOSED
CCTV 2**

PUMI
HOUSE

ONGOING ROAD WIDENING
PROJECT

GATE 1

GATE 2

WAITING
SHED





GOING TO AMAS PROVINCIAL HOSPITAL →

COVERED PATHWAY TO COT PROVINCIAL HOSPITAL

DAVAO - COTABATO ROAD

SITE DEVELOPMENT PLAN

PROPOSED CCTV CAMERA, AMAS RESERVOIR

 ISO 9001:2015 Registered Quality Management Certificate No. 66478	 UKAS MANAGEMENT SYSTEMS 477	FROM THE OFFICE OF:	DRAWN BY:	PROJECT TITLE:	PREPARED BY:	REVIEWED BY:	APPROVED BY:	SHEET NO.
		METRO KIDAPAWAN WATER DISTRICT ENGINEERING AND CONSTRUCTION DEPARTMENT PLANNING AND DESIGN DIVISION LANA-O, KIDAPAWAN CITY	ETPOLANCOS DATE: OCTOBER 2019	PROPOSED CCTV CAMERA, AMAS RESERVOIR	ELLEN T. POLANCOS, CE ACTING PROJECT IN-CHARGE, CD	RAMIL A. CONDEZ, CE, RMP, MBA DEPARTMENT MANAGER A, ECD	STELLA M. GONZALES, MPS GENERAL MANAGER	C/02
					CANUTO A. CODILLA, CE DIVISION MANAGER A, FDD	WILESPER LISANDRO M. ALQUEZA, CE, RMP, MBA AGR FOR OPERATIONS		

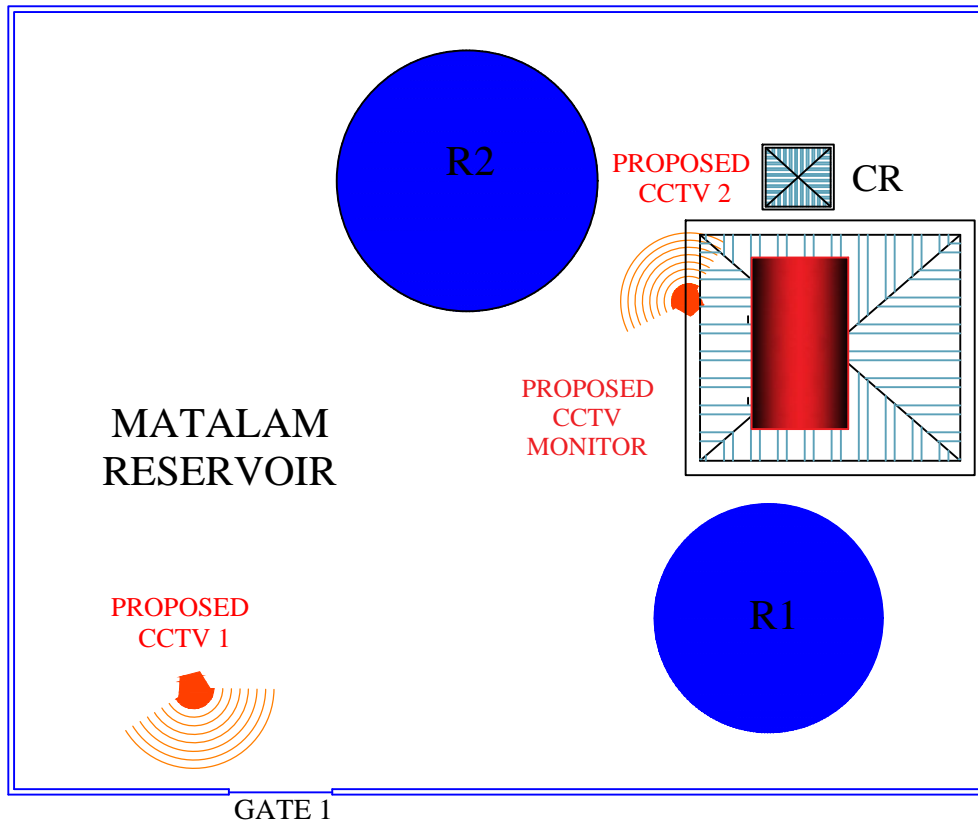

SITE DEVELOPMENT PLAN

PROPOSED CCTV CAMERA, MATALAM RESERVOIR

	FROM THE OFFICE OF: METRO KIDAPAWAN WATER DISTRICT ADMIN AND HUMAN RESOURCE DEPARTMENT GENERAL SERVICES DIVISION BRGY. LANAO, KIDAPAWAN CITY	DRAWN BY: ETPOLANCOS	PROJECT TITLE: PROPOSED CCTV CAMERA, MATALAM RESERVOIR	PREPARED BY: <u>ELLEN T. POLANCOS, CE</u> <small>ACTING PROJECT IN-CHARGE, CD</small>	REVIEWED BY: <u>RAMIL A. CONDEZ, CE, RMP, MBA</u> <small>DEPARTMENT MANAGER A, ECD</small>	APPROVED BY: <u>STELLA M. GONZALES, MPS</u> <small>GENERAL MANAGER</small>	SHEET NO. C/03
	DATE: OCTOBER 2019	CHECKED BY: <u>CANUTO A. CODILLA, CE</u> <small>DIVISION MANAGER A, PDD</small>	RECOMMENDED BY: <u>WILESPER LISANDRO M. ALQUEZA, CE, RMP, MBA</u> <small>AGT FOR OPERATIONS</small>				

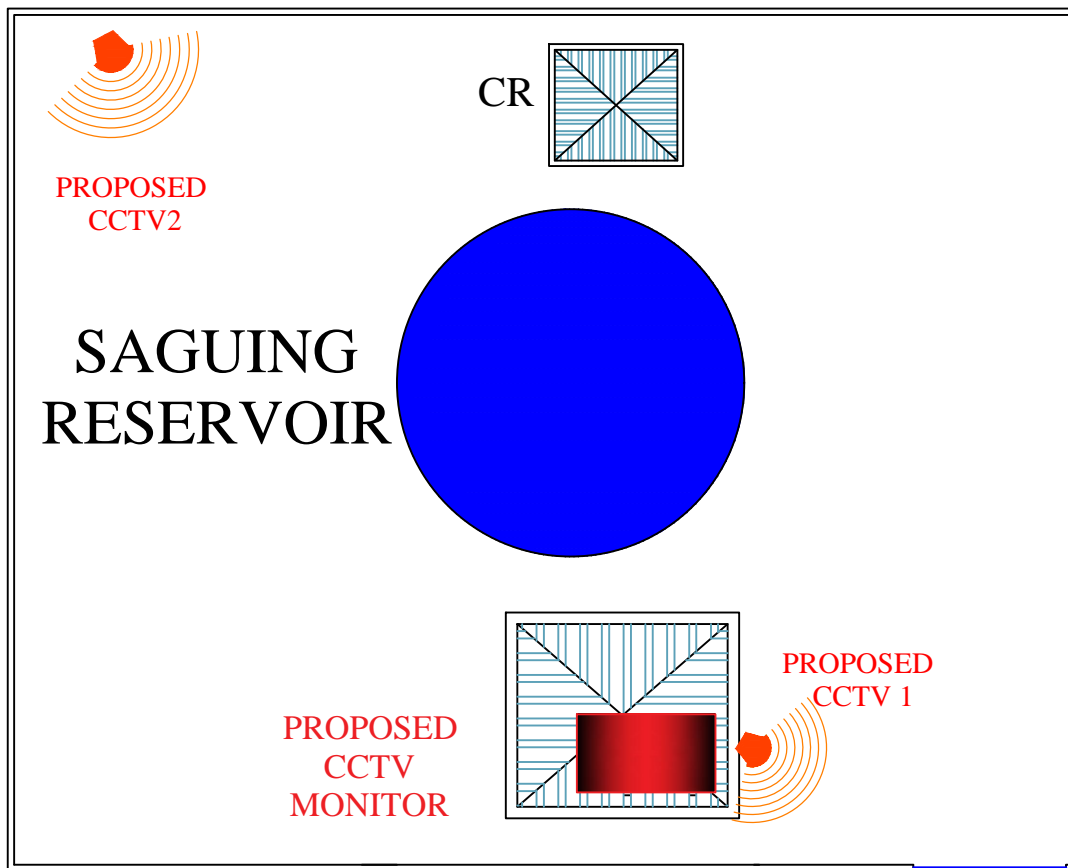

SITE DEVELOPMENT PLAN

GATE 1

PROPOSED CCTV CAMERA, SAGUING RESERVOIR

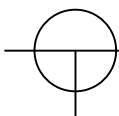

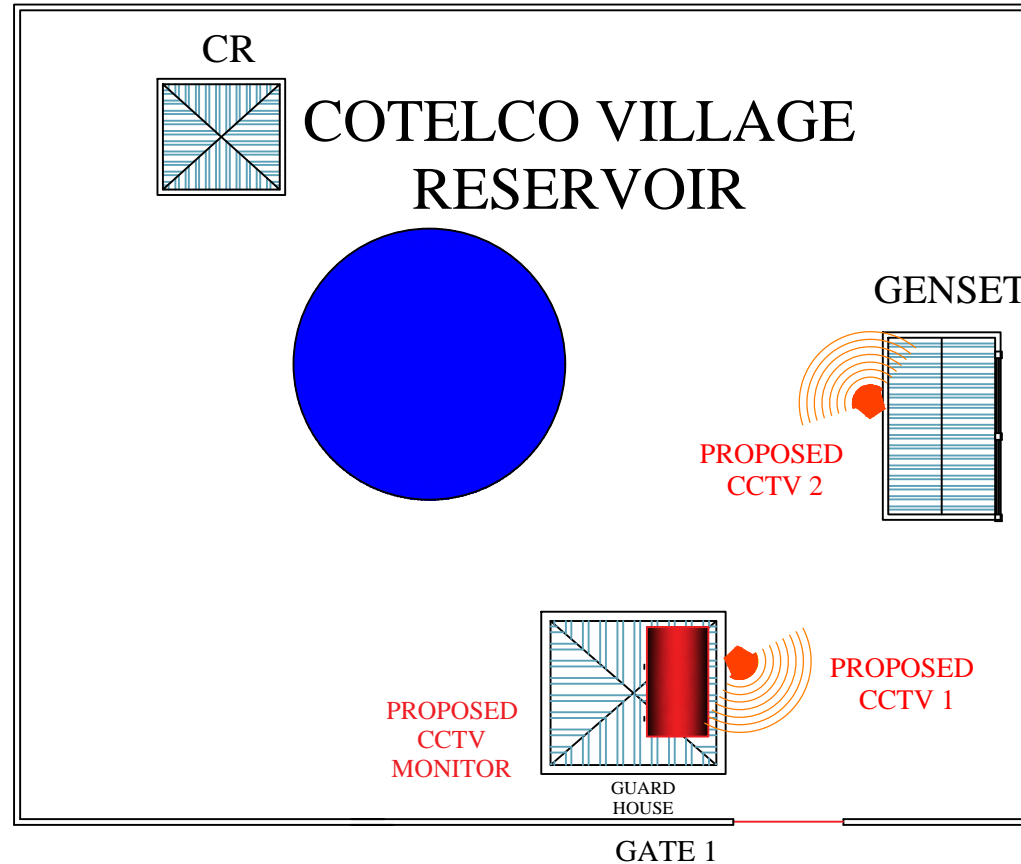

		<p>FROM THE OFFICE OF:</p> <p>METRO KIDAPAWAN WATER DISTRICT ADMIN AND HUMAN RESOURCE DEPARTMENT</p> <p>GENERAL SERVICES DIVISION BRGY. LANA O, KIDAPAWAN CITY</p>	<p>DRAWN BY:</p> <p>ETPOLANCOS</p> <p>DATE:</p> <p>OCTOBER 2019</p>	<p>PROJECT TITLE:</p> <p>PROPOSED CCTV CAMERA, SAGUING RESERVOIR</p>	<p>PREPARED BY:</p> <p>ELLEN T. POLANCOS, CE <small>ACTING PROJECT IN-CHARGE, CD</small></p> <p>CHECKED BY:</p> <p>CANUTO A. CODILLA, CE <small>DIVISION MANAGER A, PDD</small></p>	<p>REVIEWED BY:</p> <p>RAMIL A. CONDEZ, CE, RMP, MBA <small>DEPARTMENT MANAGER A, ECD</small></p> <p>RECOMMENDED BY:</p> <p>WILESPER LISANDRO M. ALQUEZA, CE, RMP, MBA <small>ADM FOR OPERATIONS</small></p>	<p>APPROVED BY:</p> <p>STELLA M. GONZALES, MPS <small>GENERAL MANAGER</small></p>	<p>SHEET NO.</p> <p>C/04</p>
--	--	--	---	---	---	--	--	-------------------------------------



SITE DEVELOPMENT PLAN

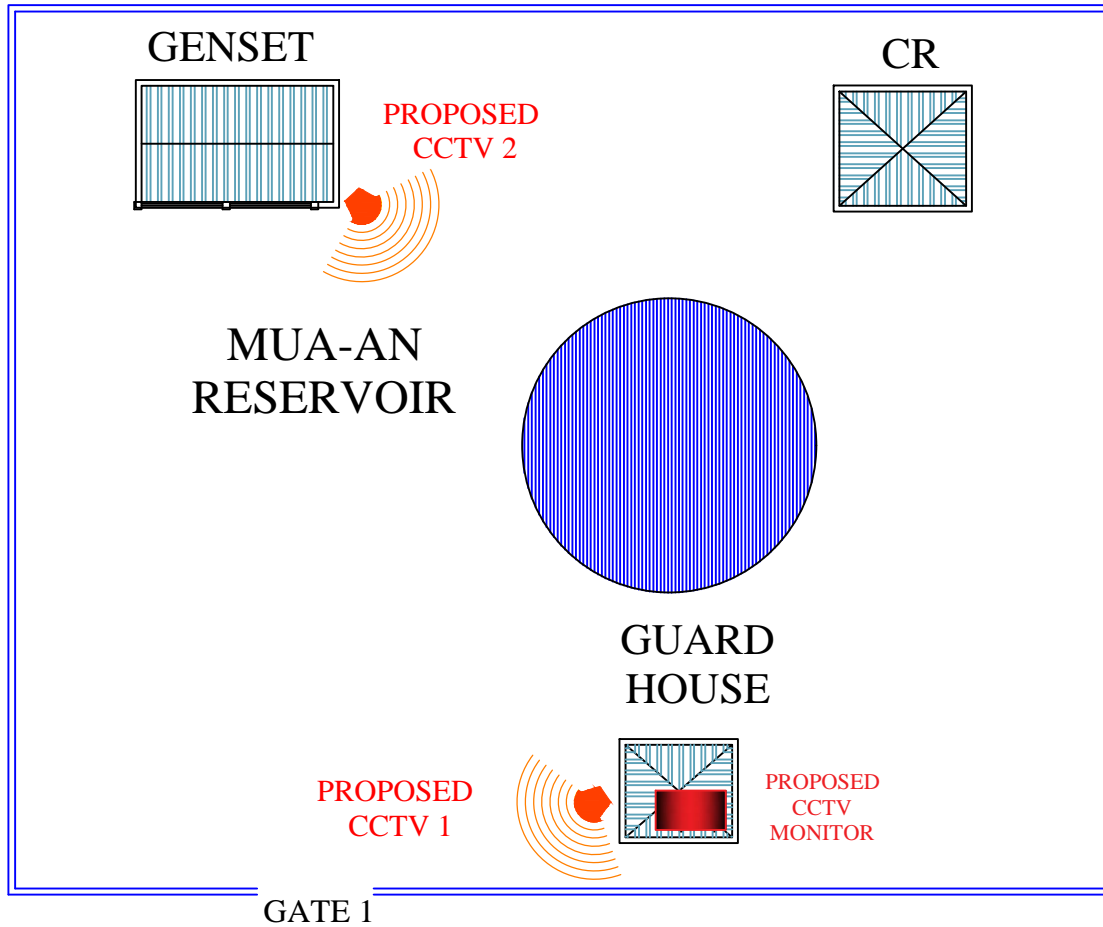

PROPOSED CCTV CAMERA, COTELCO VILLAGE RESERVOIR

		FROM THE OFFICE OF: METRO KIDAPAWAN WATER DISTRICT ADMIN AND HUMAN RESOURCE DEPARTMENT GENERAL SERVICES DIVISION BRGY. LANAOG, KIDAPAWAN CITY	DRAWN BY: ETPOLANCOS DATE: OCTOBER 2019	PROJECT TITLE: PROPOSED CCTV CAMERA, COTELCO VILLAGE RESERVOIR	PREPARED BY: <u>ELLEN T. POLANCOS, CE</u> <small>ACTING PROJECT IN-CHARGE, CD</small>	REVIEWED BY: <u>RAMIL A. CONDEZ, CE, RMP, MBA</u> <small>DEPARTMENT MANAGER A, ECD</small>	APPROVED BY: <u>STELLA M. GONZALES, MPS</u> <small>GENERAL MANAGER</small>	SHEET NO. C/05
		CHECKED BY: <u>CANUTO A. CODILLA, CE</u> <small>DIVISION MANAGER A, PSD</small>	RECOMMENDED BY: <u>WILESPER LISANDRO M. ALQUEZA, CE, RMP, MBA</u> <small>MPR FOR OPERATIONS</small>					



SITE DEVELOPMENT PLAN

PROPOSED CCTV CAMERA, MUAAN RESERVOIR

		FROM THE OFFICE OF: METRO KIDAPAWAN WATER DISTRICT ADMIN AND HUMAN RESOURCE DEPARTMENT GENERAL SERVICES DIVISION BRGY. LANAŌ, KIDAPAWAN CITY	DRAWN BY: ETPOLANCOS DATE: OCTOBER 2019	PROJECT TITLE: PROPOSED CCTV CAMERA, MUAAN RESERVOIR	PREPARED BY: <u>ELLEN T. POLANCOS, CE</u> <small>ACTING PROJECT IN-CHARGE, CD</small>	REVIEWED BY: <u>RAMIL A. CONDEZ, CE, RMP, MBA</u> <small>DEPARTMENT MANAGER A, ECD</small>	APPROVED BY: <u>STELLA M. GONZALES, MPS</u> <small>GENERAL MANAGER</small>	SHEET NO.: C/06
		CHECKED BY: <u>CANUTO A. CODILLA, CE</u> <small>DIVISION MANAGER A, PDD</small>	RECOMMENDED BY: <u>WILESPER LISANDRO M. ALQUEZA, CE, RMP, MBA</u> <small>AGN FOR OPERATIONS</small>					

MAKILALA RESERVOIR 2 (SAGUING 2)

CR

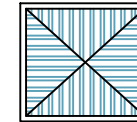

GENSET

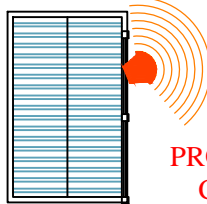

PROPOSED
CCTV 2

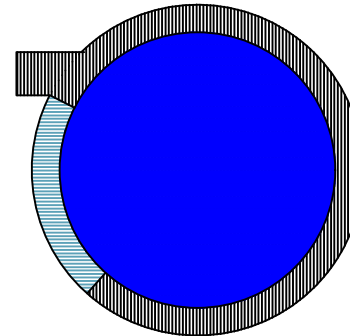

PROPOSED
CCTV
MONITOR



GUARD
HOUSE

PROPOSED
CCTV 1

GATE 1

SITE DEVELOPMENT PLAN

PROPOSED CCTV CAMERA, MAKILALA RESERVOIR 2, SAGUING



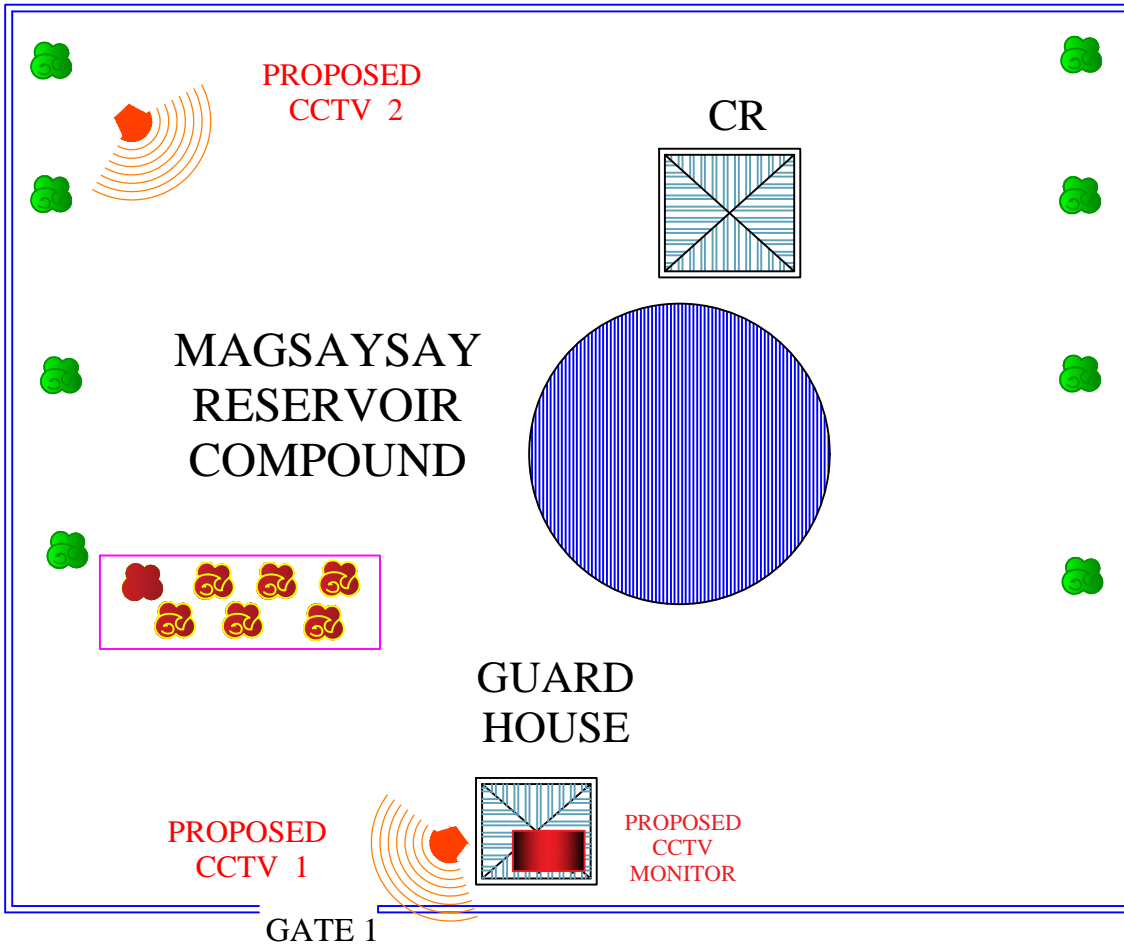

FROM THE OFFICE OF:	DRAWN BY:	PROJECT TITLE:	PREPARED BY:	REVIEWED BY:	APPROVED BY:	SHEET NO.
METRO KIDAPAWAN WATER DISTRICT ADMIN AND HUMAN RESOURCE DEPARTMENT GENERAL SERVICES DIVISION BRGY. LANAOG, KIDAPAWAN CITY	ETPOLANCOS DATE: OCTOBER 2019	PROPOSED CCTV CAMERA, MAKILALA RESERVOIR 2, SAGUING	<u>ELLEN T. POLANCOS, CE</u> <small>ACTING PROJECT IN-CHARGE, CD</small> <u>CANUTO A. CODILLA, CE</u> <small>DIVISION MANAGER A, PDD</small>	<u>RAMIL A. CONDEZ, CE, RMP, MBA</u> <small>DEPARTMENT MANAGER A, ECD</small> <u>WILESPER LISANDRO M. ALQUEZA, CE, RMP, MBA</u> <small>AGM FOR OPERATIONS</small>	<u>STELLA M. GONZALES, MPS</u> <small>GENERAL MANAGER</small>	C/07

TO MAGSAYSAY TABO
MARKET



SITE DEVELOPMENT PLAN

PROPOSED CCTV CAMERA, MAGSAYSAY RESERVOIR

 ISO 9001:2015 CERTIFIED Certificate No. 66478	 ISO 9001:2015 Registered Quality Management	 UKAS MANAGEMENT SYSTEMS 917	FROM THE OFFICE OF: METRO KIDAPAWAN WATER DISTRICT ADMIN AND HUMAN RESOURCE DEPARTMENT GENERAL SERVICES DIVISION BRGY. LANAOG, KIDAPAWAN CITY	DRAWN BY: ETPOLANCOS DATE: OCTOBER 2019	PROJECT TITLE: PROPOSED CCTV CAMERA, MAGSAYSAY RESERVOIR	PREPARED BY: ELLEN T. POLANCOS, CE ACTING PROJECT IN-CHARGE, CD CHECKED BY: CANUTO A. CODILLA, CE DIVISION MANAGER A, FPD	REVIEWED BY: RAMIL A. CONDEZ, CE, RMP, MBA DEPARTMENT MANAGER A, ECD RECOMMENDED BY: WILESPER LISANDRO M. ALQUEZA, CE, RMP, MBA ACP FPD OPERATORS	APPROVED BY: STELLA M. GONZALES, MPS GENERAL MANAGER	SHEET NO. C/08



MAKILALA RESERVOIR COMPOUND

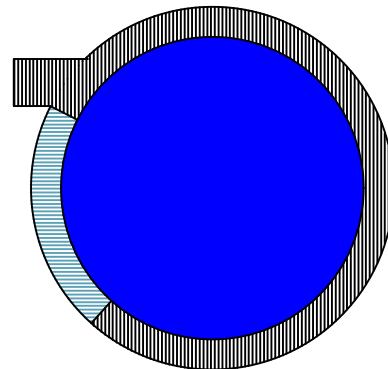

GUARD HOUSE

PROPOSED CCTV

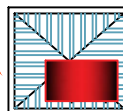



PROPOSED CCTV MONITOR

GATE 1

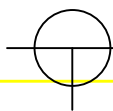
SITE DEVELOPMENT PLAN



PROPOSED CCTV CAMERA, MAKILALA RESERVOIR

	 ISO 9001:2015 CERTIFIED Certificate No. 66478	FROM THE OFFICE OF:	DRAWN BY:	PROJECT TITLE:	PREPARED BY:	REVIEWED BY:	APPROVED BY:	SHEET NO. C/09
		METRO KIDAPAWAN WATER DISTRICT ADMIN AND HUMAN RESOURCE DEPARTMENT GENERAL SERVICES DIVISION BRGY. LANAOG, KIDAPAWAN CITY	ETPOLANCOS	PROPOSED CCTV CAMERA, MAKILALA RESERVOIR	<u>ELLEN T. POLANCOS, CE</u> <small>ACTING PROJECT IN-CHARGE, CD</small>	<u>RAMIL A. CONDEZ, CE, RMP, MBA</u> <small>DEPARTMENT MANAGER A, ECD</small>	<u>STELLA M. GONZALES, MPS</u> <small>GENERAL MANAGER</small>	
			DATE:		CHECKED BY:	RECOMMENDED BY:		
			OCTOBER 2019		<u>CANUTO A. CODILLA, CE</u> <small>DIVISION MANAGER A, PSD</small>	<u>WILESPER LISANDRO M. ALQUEZA, CE, RMP, MBA</u> <small>AGT FOR OPERATORS</small>		

LEGEND:

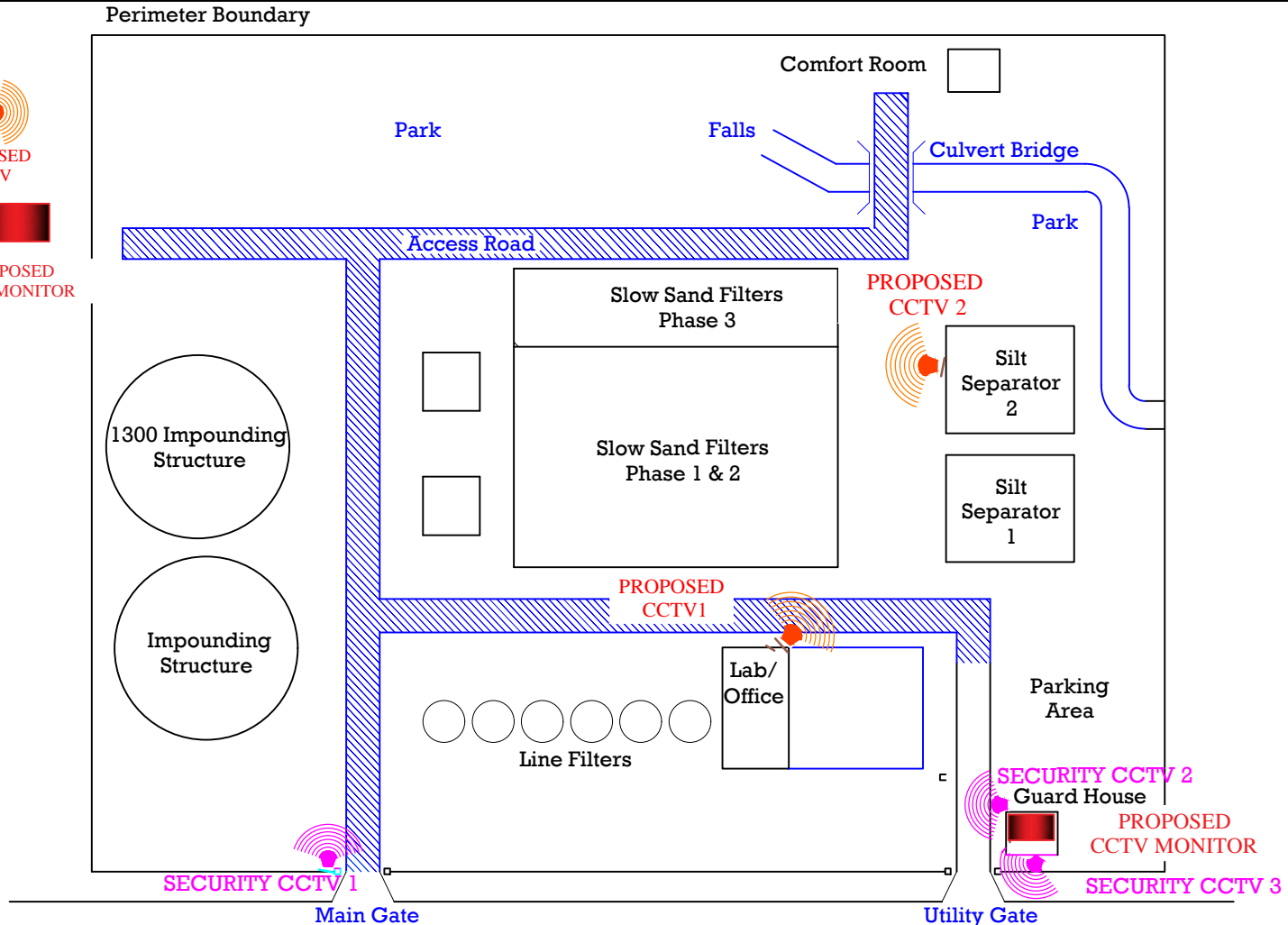
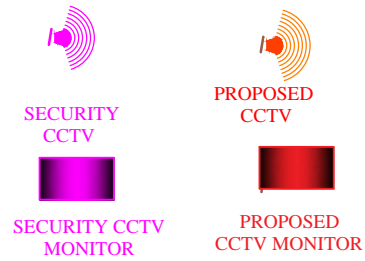

SITE DEVELOPMENT PLAN

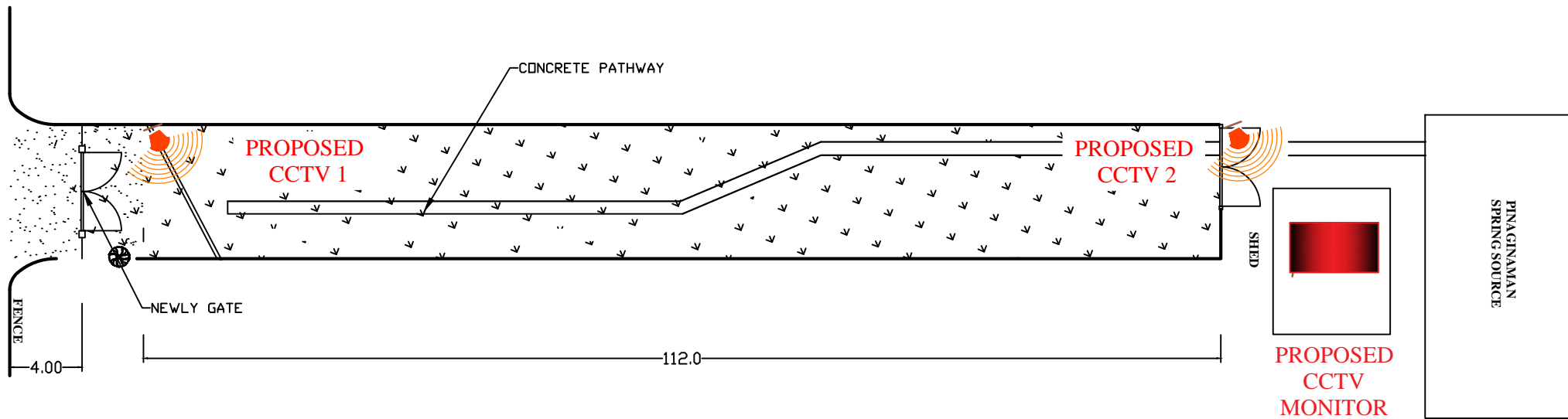

PROPOSED CCTV CAMERA, LAPAAN TREATMENT PLANT FACILITIES

		FROM THE OFFICE OF: METRO KIDAPAWAN WATER DISTRICT ADMIN AND HUMAN RESOURCE DEPARTMENT GENERAL SERVICES DIVISION BRGY. LANA O, KIDAPAWAN CITY	DRAWN BY: ETPOLANCOS DATE: OCTOBER 2019	PROJECT TITLE: PROPOSED CCTV CAMERA, LAPAAN TREATMENT PLANT FACILITIES	PREPARED BY: ELLEN T. POLANCOS, CE ACTING PROJECT IN-CHARGE, CD	REVIEWED BY: RAMIL A. CONDEZ, CE, RMP, MBA DEPARTMENT MANAGER A, ECD	APPROVED BY: STELLA M. GONZALES, MPS GENERAL MANAGER	SHEET NO. C/11
		CHECKED BY: CANUTO A. CODILLA, CE DIVISION MANAGER A, PDD	RECOMMENDED BY: WILESPER LISANDRO M. ALQUEZA, CE, RMP, MBA AGM FOR OPERATIONS					



SITE DEVELOPMENT PLAN

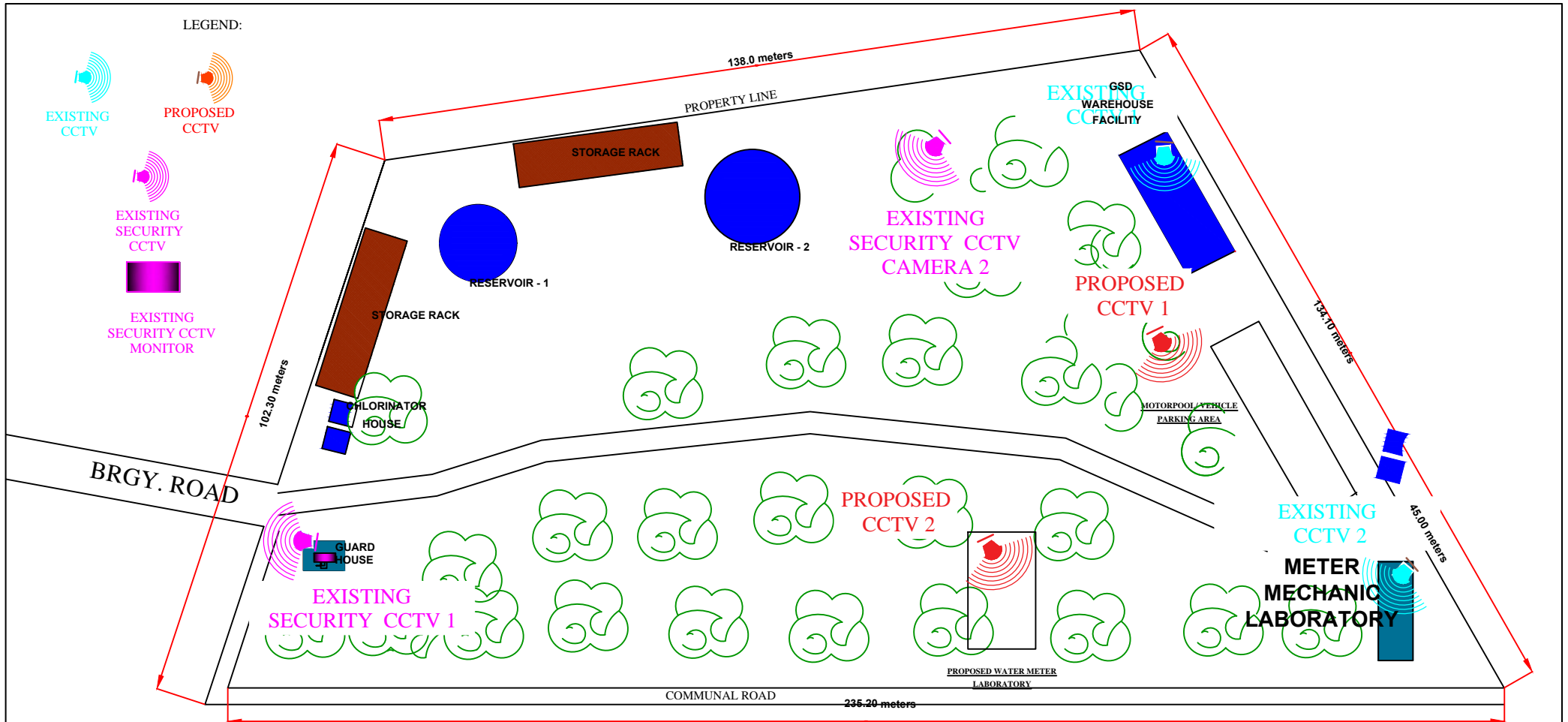

PROPOSED CCTV CAMERA, PINAG INAMAN SPRING SOURCE

	 ISO 9001:2015 CERTIFIED Certificate No. 66478	FROM THE OFFICE OF:	DRAWN BY:	PROJECT TITLE:	PREPARED BY:	REVIEWED BY:	APPROVED BY:	SHEET NO.
		METRO KIDAPAWAN WATER DISTRICT ADMIN AND HUMAN RESOURCE DEPARTMENT GENERAL SERVICES DIVISION BRGY. LANAOG, KIDAPAWAN CITY	<u>ETPOLANCOS</u> DATE: OCTOBER 2019	PROPOSED CCTV CAMERA, PINAG INAMAN SPRING SOURCE	<u>ELLEN T. POLANCOS, CE</u> CHECKED BY: <u>CANUTO A. CODILLA, CE</u> <small>DIVISION MANAGER A, PDD</small>	<u>RAMIL A. CONDEZ, CE, RMP, MBA</u> <small>DEPARTMENT MANAGER A, ECI</small> RECOMMENDED BY: <u>WILESPER LISANDRO M. ALQUEZA, CE, RMP, MBA</u> <small>MAN FOR OPERATIONS</small>	<u>STELLA M. GONZALES, MPS</u> <small>GENERAL MANAGER</small>	C/12



SITE DEVELOPMENT PLAN

PROPOSED CCTV CAMERA, MANONGOL RESERVOIR COMPLEX

		FROM THE OFFICE OF: METRO KIDAPAWAN WATER DISTRICT ADMIN AND HUMAN RESOURCE DEPARTMENT GENERAL SERVICES DIVISION BRGY. LANAO, KIDAPAWAN CITY	DRAWN BY: ETPOLANCOS DATE: OCTOBER 2019	PROJECT TITLE: PROPOSED CCTV CAMERA, MANONGOL RESERVOIR COMPLEX	PREPARED BY: ELLEN T. POLANCOS, CE	REVIEWED BY: RAMIL A. CONDEZ, CE, RMP, MBA <small>DEPARTMENT MANAGER A, ECD</small>	APPROVED BY: STELLA M. GONZALES, MPS <small>GENERAL MANAGER</small>	SHEET NO. C/13
		CHECKED BY: CANUTO A. CODILLA, CE <small>DIVISION MANAGER A, PDB</small>	RECOMMENDED BY: WILESPER LISANDRO M. ALQUEZA, CE, RMP, MBA <small>AGT FOR OPERATIONS</small>					

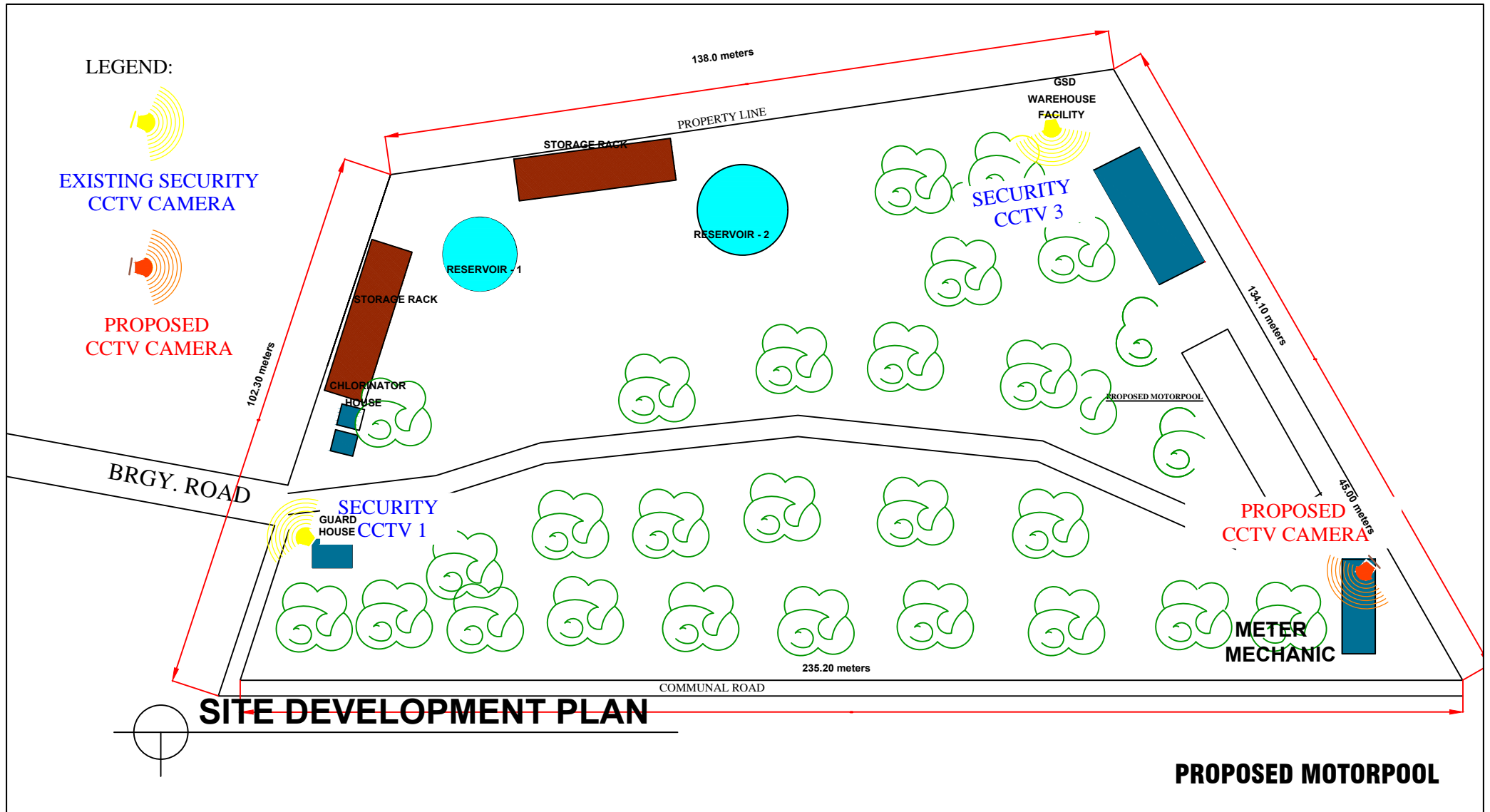

FROM THE OFFICE OF:	DRAWN BY:	PROJECT TITLE:	PREPARED BY:	REVIEWED BY:	APPROVED BY:	SHEET NO.
<p>METRO KIDAPAWAN WATER DISTRICT ADMIN AND HUMAN RESOURCE DEPARTMENT GENERAL SERVICES DIVISION BRGY. LANA O, KIDAPAWAN CITY</p>	<p>ETPOLANCOS</p> <p>DATE:</p> <p>AUGUST 2018</p>	<p>PROPOSED MOTORPOOL</p>	<p>ELLEN T. POLANCOS, CE Assisting Staff to GS Chief II</p>	<p>ROSAURO O. DAGA, MBA DEPARTMENT MANAGER II, A & HR</p>	<p>STELLA M. GONZALES, MPS GENERAL MANAGER</p>	<p>C/14</p>
	<p>CHECKED BY:</p> <p>LEONARDO J. CENAR, MPS DIVISION MANAGER II, GS</p>		<p>RECOMMENDED BY:</p> <p>WILESPER LISANDRO M. ALQUEZA, CE, RMP, MBA AGM FOR OPERATIONS</p>			

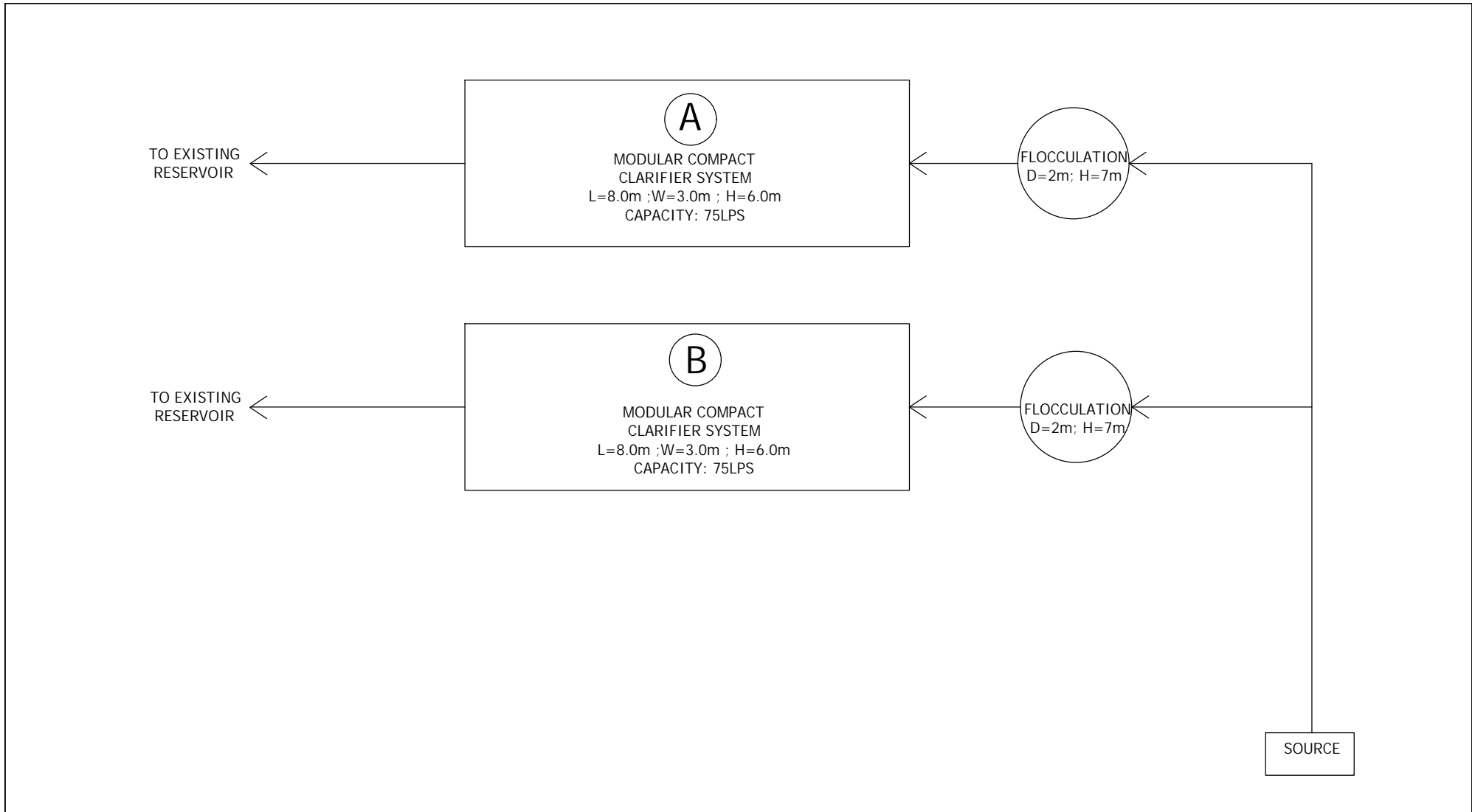

	<p>ISO 9001:2015 CERTIFIED Certificate No. 66478</p>	<p>FROM THE OFFICE OF: METRO KIDAPAWAN WATER DISTRICT ENGINEERING AND CONSTRUCTION DEPARTMENT PLANNING AND DESIGN DIVISION LANAO, KIDAPAWAN CITY</p>	<p>DRAWN BY: GLYZT DATE: MAY 2020</p>	<p>TITLE: SCHEMATIC DIAGRAM MODULAR TREATMENT FACILITY</p>	<p>PREPARED BY: <u>GLYZIEL D. TUMACLAS, CE</u> JOB ORDER PSD CHECKED BY: <u>CANUTO A. CODILLA, CE</u> DIVISION MANAGER, PSD</p>	<p>NOTED BY: ENGR. RAMIL A. CONDEZ, RMP/MBA DEPARTMENT MANAGER, ECD RECOMMENDED BY: ENGR. WLISANDRO M. ALQUEZA, RMP/MBA ASST. FOR OPERATIONS</p>	<p>APPROVED BY: <u>STELLA M. GONZALES, MPS</u> GENERAL MANAGER</p>	<p>SHEET NO. M 01</p>
--	--	--	--	---	--	---	--	--------------------------------------